

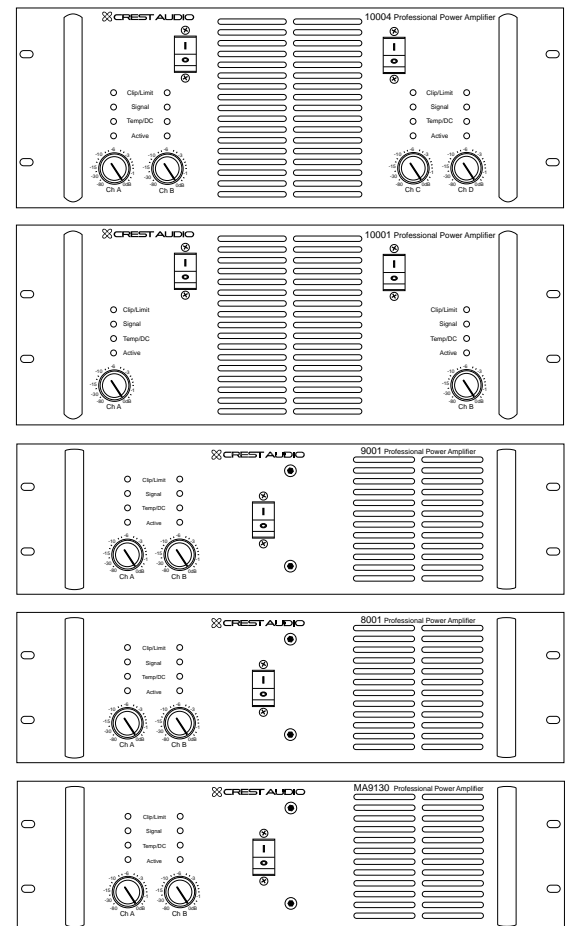

PRO

PROFESSIONAL POWER AMPLIFIERS

SERIES

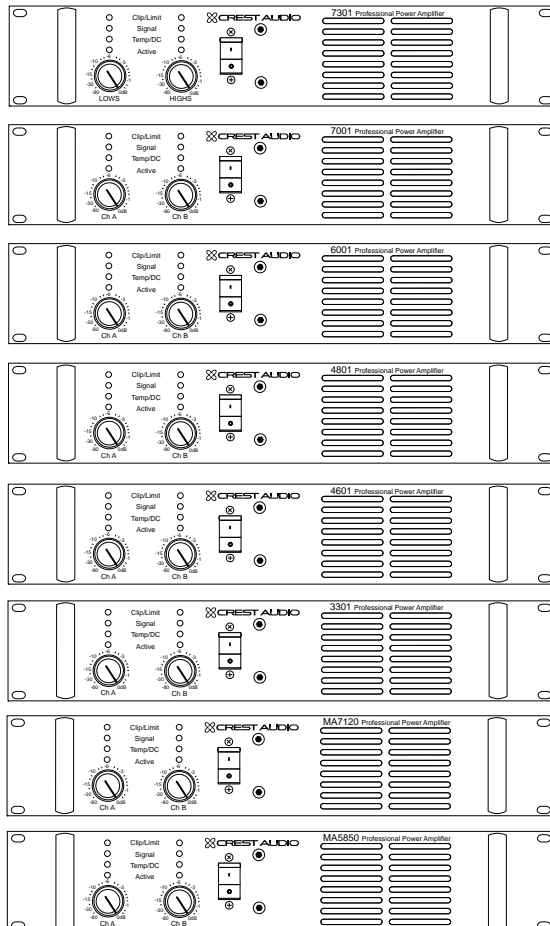

OWNER'S MANUAL

Including MA Series Amplifiers

Important Precautions



This symbol is used to alert the operator to follow important operating procedures and precautions detailed in documentation.



This symbol is used to warn operators that uninsulated "dangerous voltages" are present within the equipment enclosure that may pose a risk of electric shock.

- 1. Save the carton and packing material even if the equipment has arrived in good condition.** Should you ever need to ship the unit, use only the original factory packing.
- 2. Read all documentation before operating your equipment.** Retain all documentation for future reference.
- 3. Follow all instructions** printed on unit chassis for proper operation.
- 4. Do not spill water or other liquids into or on the unit,** or operate the unit while standing in liquid.
- 5. Make sure power outlets conform to the power requirements** listed on the back of the unit.
- 6. Do not use the unit if the electrical power cord is frayed or broken.** The power supply cords should be routed so that they are not likely to be walked on or pinched by items placed upon or against them, paying particular attention to cords and plugs, convenience receptacles, and the point where they exit from the appliance.
- 7. Always operate the unit with the AC ground wire connected** to the electrical system ground. Precautions should be taken so that the means of grounding of a piece of equipment is not defeated.
- 8. Mains voltage must be correct and the same as that printed on the rear of the unit.** Damage caused by connection to improper AC voltage is not covered by any warranty.
- 9. Have gain controls on amplifiers turned down during power-up** to prevent speaker damage if there are high signal levels at the inputs.
- 10. Power down & disconnect units from mains voltage before making connections.**
- 11. Never hold a power switch in the "ON" position if it won't stay there itself!**
- 12. Do not use the unit near stoves, heat registers, radiators, or other heat producing devices.**
- 13. Do not block fan intake or exhaust ports.** Do not operate equipment on a surface or in an environment which may impede the normal flow of air around the unit, such as a bed, rug, weather-sheet, carpet, or completely enclosed rack. If the unit is used in an extremely dusty or smoky environment, the unit should be periodically "blown free" of foreign matter.
- 14. Do not remove the cover.** Removing the cover will expose you to potentially dangerous voltages. There are no user serviceable parts inside.
- 15. Connecting amplifier outputs to oscilloscopes or other test equipment** while the amplifier is in bridged mode may damage both the amplifier and test equipment!
- 16. Do not drive the inputs with a signal level greater than that required to drive equipment to full output.**
- 17. Do not connect the inputs / outputs of amplifiers or consoles to any other voltage source,** such as a battery, mains source, or power supply, regardless of whether the amplifier or console is turned on or off.
- 18. Do not run the output of any amplifier channel back into another channel's input. Do not parallel- or series-connect an amplifier output with any other amplifier output.** Crest Audio is not responsible for damage to loudspeakers for any reason.
- 19. Do not ground any + ("hot") terminal. Never connect a + ("hot") output to ground or to another + ("hot") output!**
- 20. Non-use periods.** The power cord of equipment should be unplugged from the outlet when left unused for a long period of time.
- 21. Service Information** Equipment should be serviced by qualified service personnel when:
 - A.** The power supply cord or the plug has been damaged;
 - B.** Objects have fallen, or liquid has been spilled into the equipment;
 - C.** The equipment has been exposed to rain;
 - D.** The equipment does not appear to operate normally, or exhibits a marked change in performance;
 - E.** The equipment has been dropped, or the enclosure damaged.
- 22. To obtain service,** contact your nearest Crest Audio Service Center, Distributor, Dealer, or Crest Audio at 201.909.8700 (USA).



All Professional Series power amplifier models are UL LISTED, except for:

10001
10004
MA5850
MA7120
MA9130

Power Amplifier Owner's Manual

Table of Contents

Introduction	2
Unpacking	2
Mounting	2
Cooling Requirements	3
Operating Precautions.	3
Crest Audio Model 7301 Power Amplifier	3
Crest Audio Model 10004 Power Amplifier	3
Models 3301, 4801, 6001 Features	4
Model 4601 Features	4
Model 7001 Features	5
Model 7301 Features	5
Model 8001 Features	6
Model 9001 Features	7
Model 10001 Features	8
Model 10004 Features	9
Connecting Inputs.	10
Connecting Outputs	10
Crest Audio Octal Sockets	10
NexSys®	10
Connecting Power.	11
Operation Modes	11
Bridging Precautions	12
Switches and Controls	12
Indicators	13
Protection Features	13
Speaker Protection	15
Amplifier Maintenance and User Responsibility	15
Service/Warranty Information	15
Professional Series Block Diagram	Appendix A
General Amplifier Specifications	Appendix B
Wire Gauge Charts.	Appendix C
Meyer-Compatible Power Amplifiers	Appendix D

Introduction

Congratulations...on your purchase of a Crest Audio Professional Series power amplifier. Designed for years of reliable, flawless operation under rigorous use. These power amplifiers offer the sonic superiority and unsurpassed reliability for which Crest Audio is famous, while remaining surprisingly compact. Advanced technology and extensive protection circuitry allow operation with greater efficiency into difficult loads and power conditions. All Professional Series amplifiers are fully compatible with Crest Audio's Octal Socket Accessories and the NexSys computer-controlled audio system. The IGM (Instantaneous Gain Modulation) circuit ensures trouble-free operation into loads as low as 2Ω . The clip limiting circuits protect drivers and ensure that sonic integrity is maintained, even in extreme overload conditions. Crest Audio's high-efficiency design uses tunnel-cooled heatsinks and variable speed DC fans. This cooling topology maintains a lower overall operating temperature, resulting in longer output transistor life.

Model 9001, 10001, and 10004 power amplifiers use Crest Audio's innovative "Power Density" circuitry.

Although the Crest Audio Professional Series amplifiers are quite simple to operate, and are housed in ultra-strong steel chassis, improper use can be dangerous. Some of these models are very high-powered amplifiers that can put out high voltages and sizable currents at frequencies up to 30 kHz. Always use safe operating techniques with these amplifiers. ***FOR YOUR SAFETY, READ THE IMPORTANT PRECAUTIONS SECTION, AS WELL AS INPUT, OUTPUT, AND POWER CONNECTION SECTIONS.***

Unpacking

Upon unpacking, inspect the amplifier. If you find any damage, notify your supplier immediately. Only the consignee may institute a claim with the carrier for damage incurred during shipping. Be sure to save the carton and all packing materials. Should you ever need to ship the unit back to Crest Audio, one of its offices, service centers, or the supplier, use only the original factory packing. If the shipping carton is unavailable, contact Crest to obtain a replacement.

Mounting

Professional Series power amplifiers will mount in standard 19-inch racks having sufficient depth. The 10004 & 10001 amplifiers are four rack units high; the 9001 and 8001 models are three rack-spaces high, while the remainder are two rack-space units. All two and three-rack space units (except for the 9001) are provided with four front panel mounting holes. The 9001, 10001, and 10004 have eight front panel mounting holes. Crest Audio recommends using all mounting holes to secure the power amplifier in the rack; this will ensure the safety of the equipment. Rear mounting ears are also provided on all amplifiers for additional support, which is essential in non-permanent installations like mobile or touring sound systems, but recommended for permanent installations as well. Because of the cables and connectors on the rear panel, a right-angle or offset screwdriver or hex key will make it easier to fasten the rear mounting ears to the rails.

Note: The 10001 and 10004 models, because of their size, require rack mounting screws stronger than standard rack screws. For customers in the USA, these are supplied with the unit. Customers in Europe and Asia should mount these models using heavy-duty metric bolts.

Cooling Requirements

The Professional Series amplifiers use a forced-air cooling system to maintain a low, even operating temperature. Air is drawn into the amplifier by fan(s) on the rear panel, courses through the cooling fins of the back-to-back (tunnel-configured) channel heat sinks, and then exhausts through the front panel slots.

If either heat sink gets too hot, its sensing circuit will open the output relay, disconnecting the load from that particular channel. If the power transformer overheats, another sensing circuit opens the output relays on all channels until it cools to a safe temperature.

It is important to have an adequate air supply at the back of the amplifier and enough space around the front of the amplifier to allow the cooling air to escape. If the amp is rack mounted, do not use doors or covers on the front of the rack; the exhaust air must flow without resistance. If you are using racks with closed backs, use fans on the rear rack panel to pressurize the rack and ensure an ample air supply; also make sure that there is one (1) standard rack space opening for every three mounted power amplifiers.

The Professional Series amplifiers are supplied with cooling fan air filters. The filters snap in place over the fan housing. Any filter will decrease airflow somewhat, so use the filter only when the amplifier is used in a dusty environment without a filtered air supply. The filter element must be cleaned or replaced periodically (see the section on Amplifier Maintenance for filter service procedures).

Operating Precautions

Make sure the mains voltage is correct and is the same as that printed on the rear of the amplifier. Damage caused by connecting the amplifier to improper AC voltage is not covered by any warranty. See the *Connecting Power* section for more information on voltage requirements.

Note: Always turn off and disconnect the amplifier from mains voltage before making audio connections. Also, as an extra precaution, have the attenuators turned down during power-up.

Although the Professional Series amplifiers have AutoRamp circuitry, which raises the signal level gradually after the output relay closes, it is always a good idea to have the gain controls turned down during power-up to prevent speaker damage if there is a high signal level at the inputs. Whether you buy or make them, use good-quality connections, input cables, and speaker cables, along with good soldering technique, to ensure trouble-free operation. Most intermittent problems are caused by faulty cables.

Consult the Wire Gauge Charts to determine proper gauges for different load impedances and cable lengths. Remember that cable resistance robs amplifier power in two ways: power lost directly to resistance (I^2R loss), and by lowering the total load impedance. Also make sure the mode switch is correctly set for the desired application. See Sections on Stereo, Parallel, and Bridged Mono Operation for more information.

The Crest Audio Model 7301 Power Amplifier

The Model 7301 is specifically designed for use in bi-amplified systems; because of its dissimilar channel design, the specifications are reported in a separate fashion. The 7301 power specifications were obtained by driving the low frequency channel with a 100 Hz signal and the high frequency channel with a 1 kHz signal.

The Crest Audio Model 10004 Power Amplifier

The Model 10004 power amplifier is unique in that it is a high-power, four-channel amplifier. Offering the advantages of Crest Audio's Power Density engineering design philosophy, this amplifier provides 1400 watts at 2Ω from each of the four channels. All four channels have independent LED indicators, attenuation, and input/output connections. Power switching and NexSys interfaces are configured in pairs of two. Because a channel may have to drive more than one speaker line, each channel has two pairs of output binding posts. The red binding posts are hot (+), while the black binding posts are at signal ground (-).

Models 3301, 4801, 6001 Features

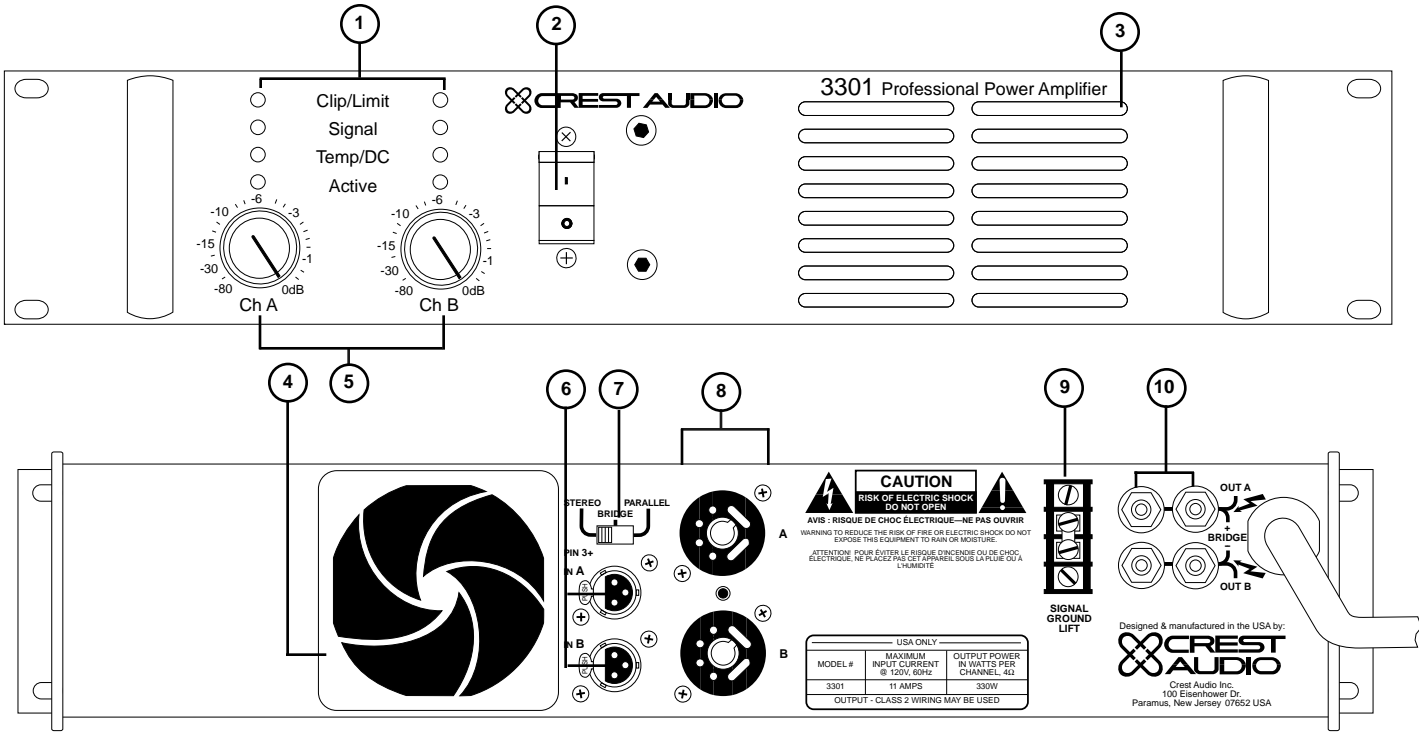

1-Channel A & B Clip/Limit, Signal, Temp/DC, and Active LEDs. 2-Combination Circuit Breaker/Power Switch. 3-Heated Air Exhaust Grill. 4-Fan Intake Grill & Filter 5-Channel A & B Gain Attenuators. 6-Channel A & B XLR Input Connectors. 7-Mode Select Switch. 8-Crest Audio Octal Accessory Sockets. 9-Signal Ground Lift Barrier Strip. 10-Five-Way Output Binding Post Connectors.

Model 4601 & 7001 Features

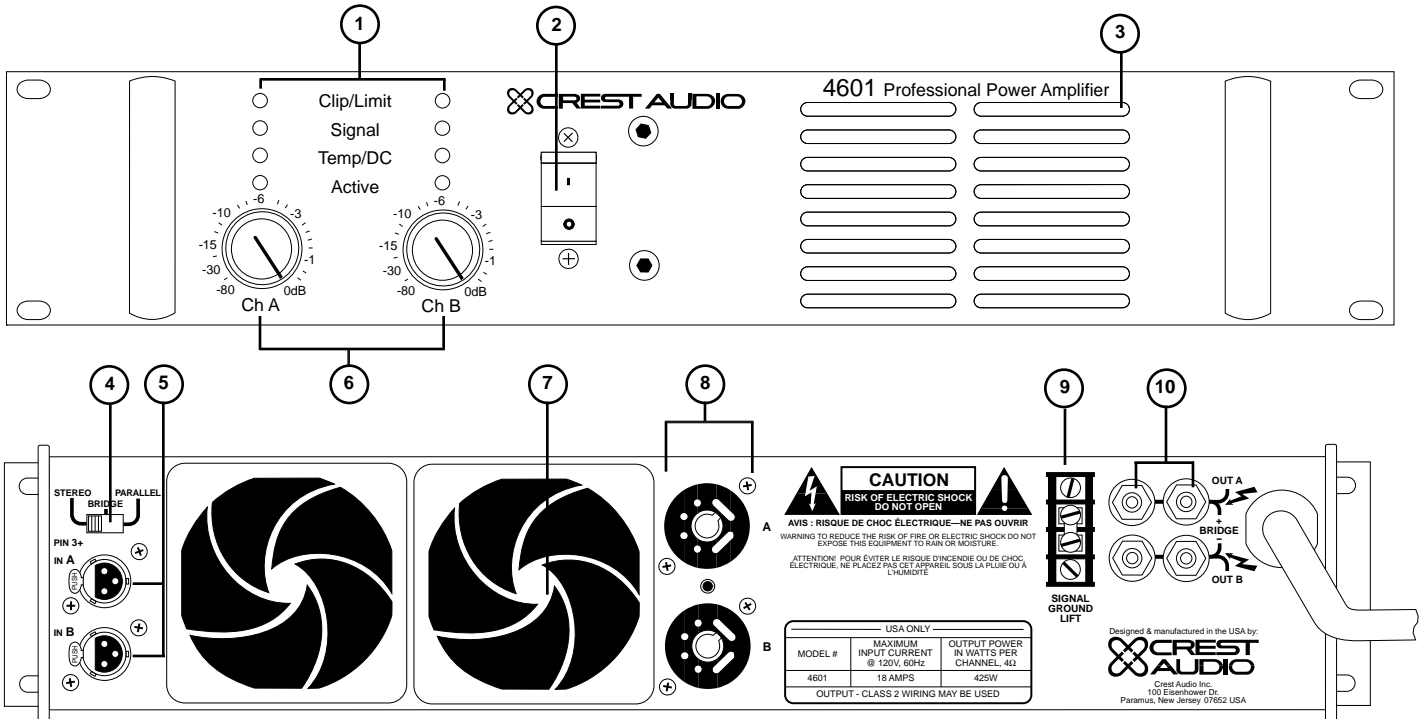

1-Channel A & B Clip/Limit, Signal, Temp/DC, and Active LEDs. 2-Combination Circuit Breaker/Power Switch. 3-Heated Air Exhaust Grill. 4-Mode Select Switch. 5-Channel A & B XLR Input Connectors. 6-Channel A & B Gain Attenuators. 7-Fan Intake Grills & Filters. 8-Crest Audio Octal Accessory Sockets 9-Signal Ground Lift Barrier Strip. 10-Five-Way Output Binding Post Connectors.

Model 7301 Features

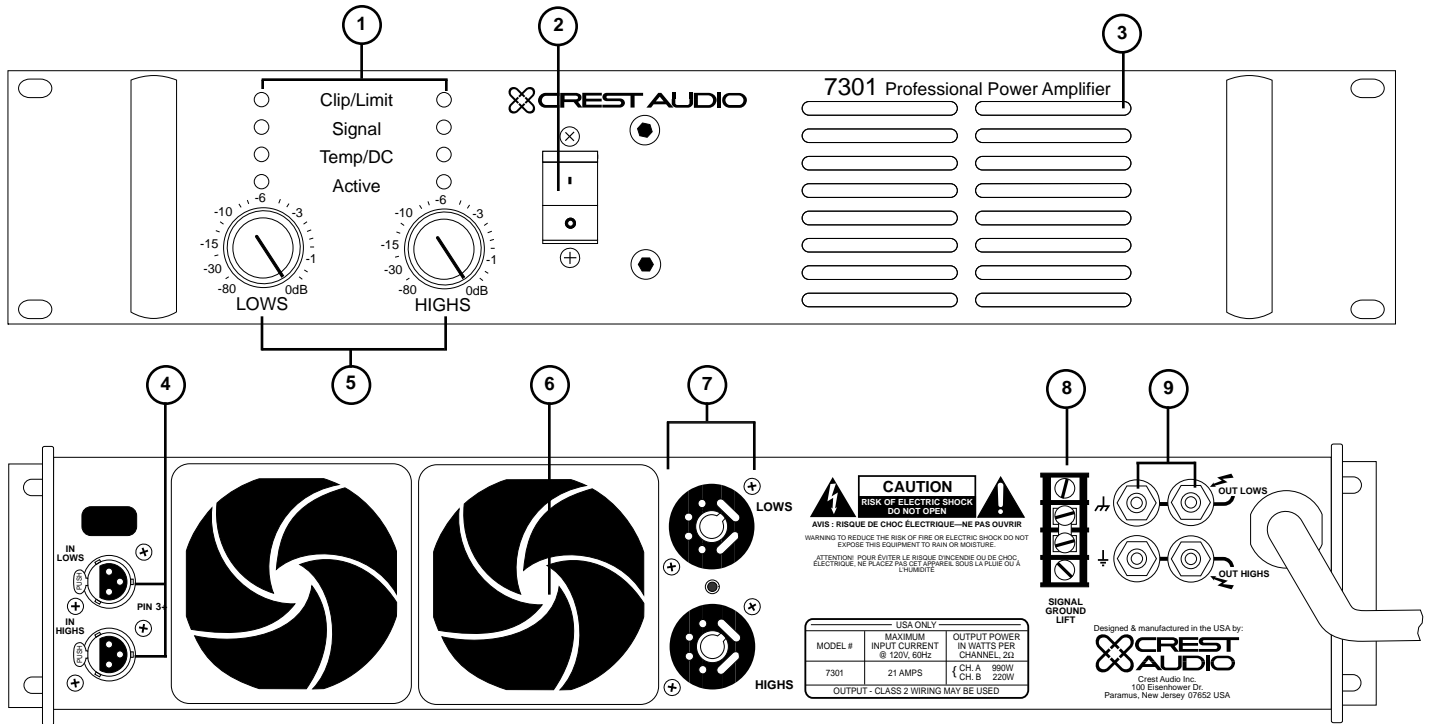

- 1-Lows and Highs Channel Clip/Limit, Signal, Temp/DC, and Active LEDs.
- 2-Combination Circuit Breaker/Power Switch.
- 3-Heated Air Exhaust Grill.
- 4-Lows and Highs Channel XLR Input Connectors.
- 5-Lows and Highs Channel Attenuators.
- 6-Fan Intake Grills & Filters.
- 7-Crest Audio Octal Accessory Sockets.
- 8-Five-Way Output Binding Post Connectors.
- 9-Signal Ground Lift Barrier Strip.

Model 8001 Features

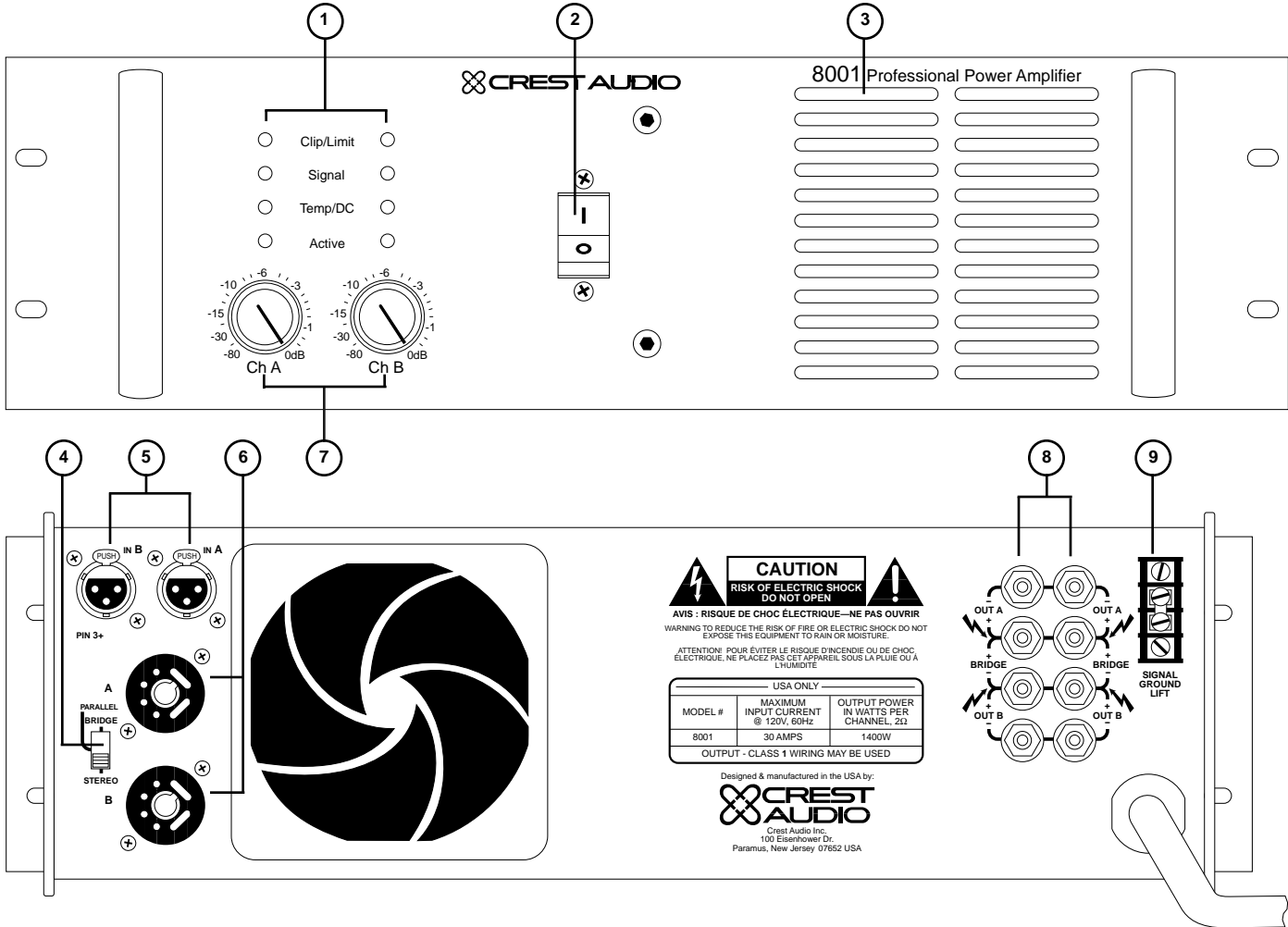

- 1-Front Panel Channel Clip/Limit, Signal, Temp/DC, and Active LEDs. 2-Combination Circuit Breaker/Power Switch.
- 3-Heated Air Exhaust Grill. 4-Mode Select Switch. 5-XLR Input Connectors. 6-Crest Audio Octal Socket Accessory Connectors.
- 7-Channel A & B Attenuators. 8-Five-Way Output Binding Post Connectors. 9-Signal Ground Lift Barrier Strip.

Model 9001 Features

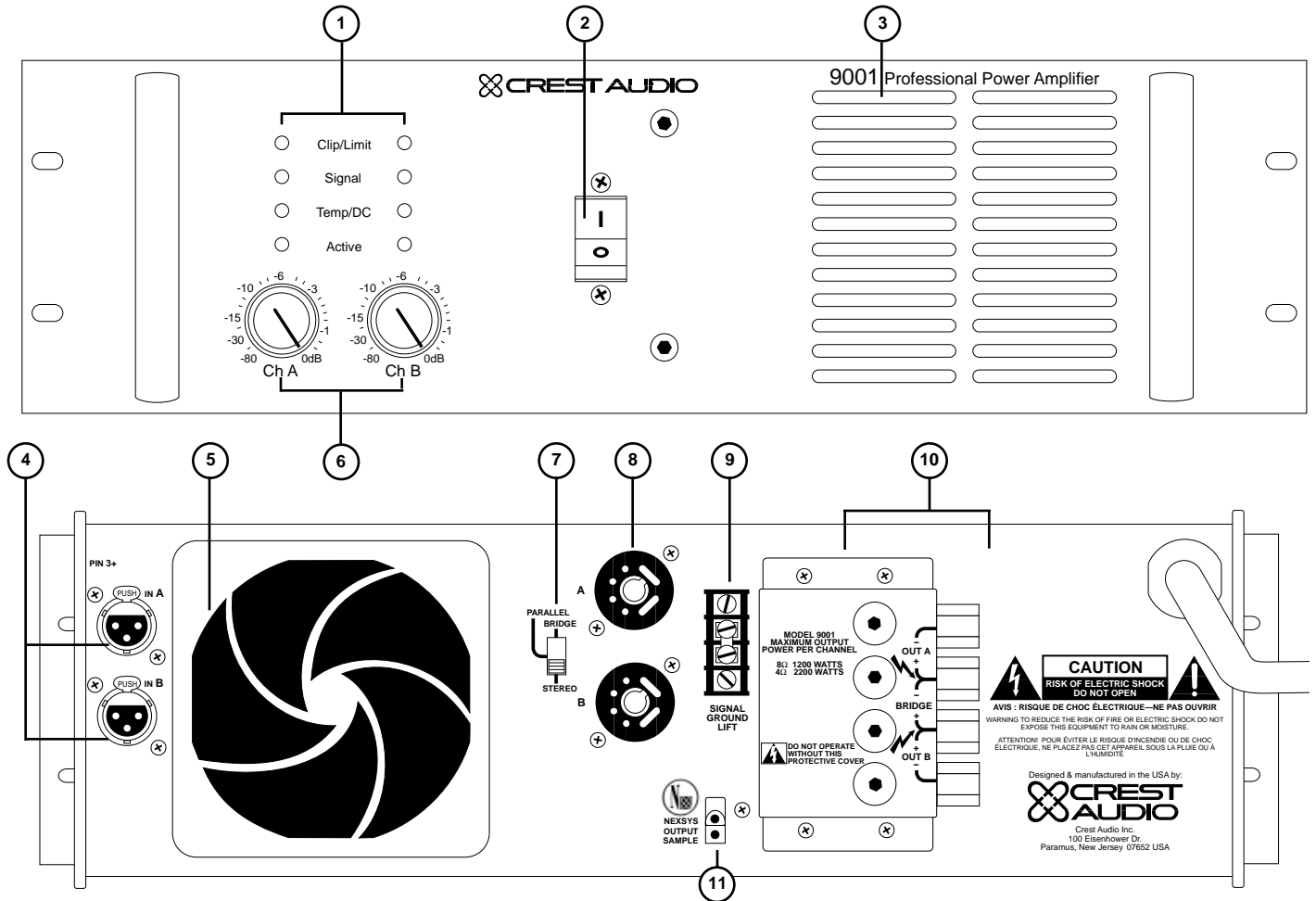

- 1-Front Panel Channel Clip/Limit, Signal, Temp/DC, and Active LEDs. 2-Combination Circuit Breaker/Power Switch.
- 3-Heated Air Exhaust Grill. 4-XLR Input Connectors. 5-Air Intake/Fan Filter. 6-Channel Attenuators.
- 7-Mode Select Switch 8-Crest Audio Octal Socket Accessory Connectors.
- 9-Signal Ground Lift Barrier Strip. 10-Single-Screw Solderless Output Connectors. 11-NexSys Output Sample Connector

Model 10001 Features

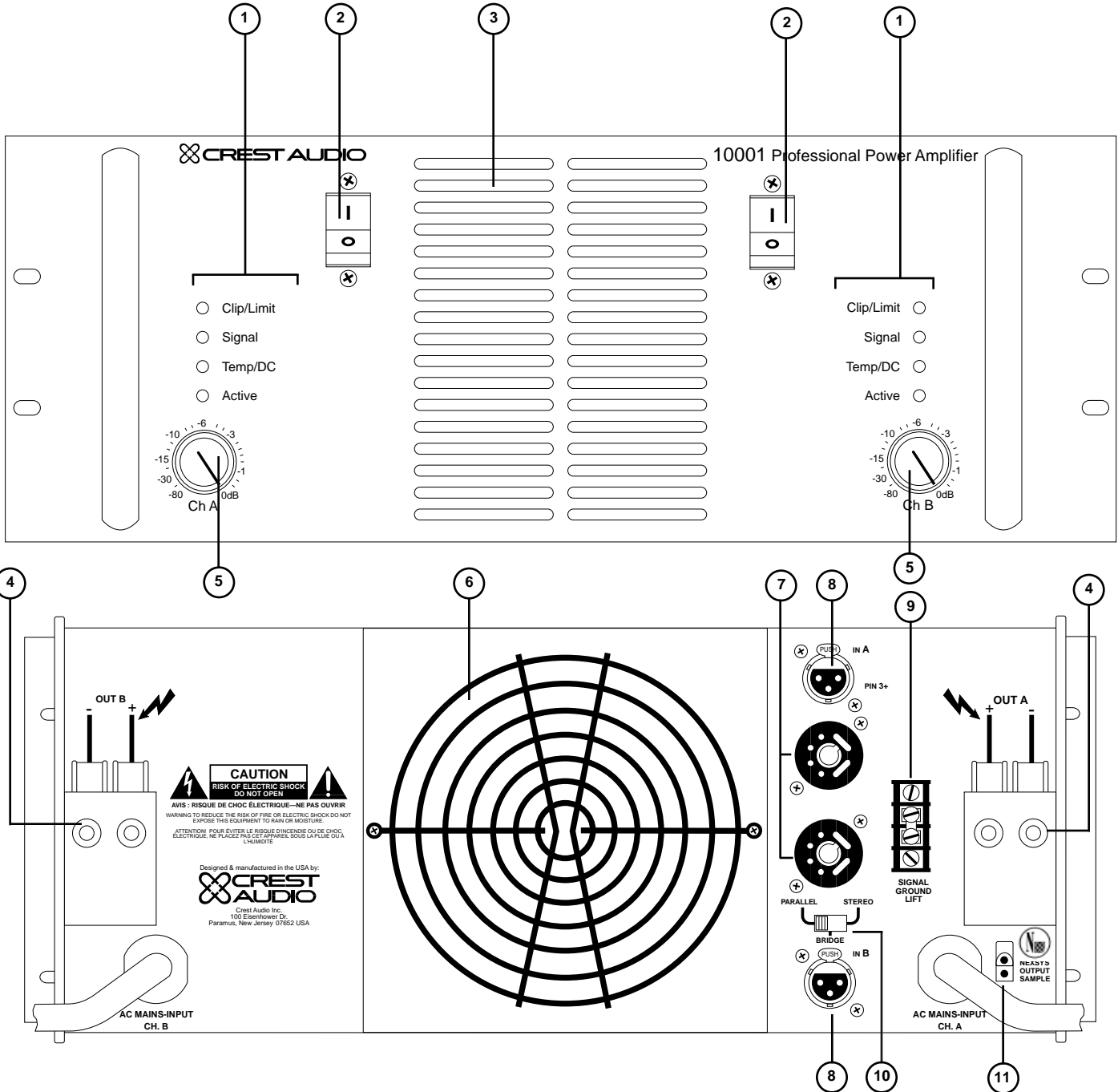

- 1-Front Panel Channel Clip/Limit, Signal, Temp/DC, and Active LEDs.
- 2-Combination Circuit Breaker/Power Switch.
- 3-Heated Air Exhaust Grill.
- 4-Single-Screw Solderless Output Connectors.
- 5-Channel Attenuators.
- 6-Air Intake/Fan Filter.
- 7-Crest Audio Octal Socket Accessory Connectors.
- 8-XLR Input Connectors.
- 9-Signal Ground Lift Barrier Strip.
- 10-Mode Select Switch
- 11-NexSys Output Sample Connector

Model 10004 Features

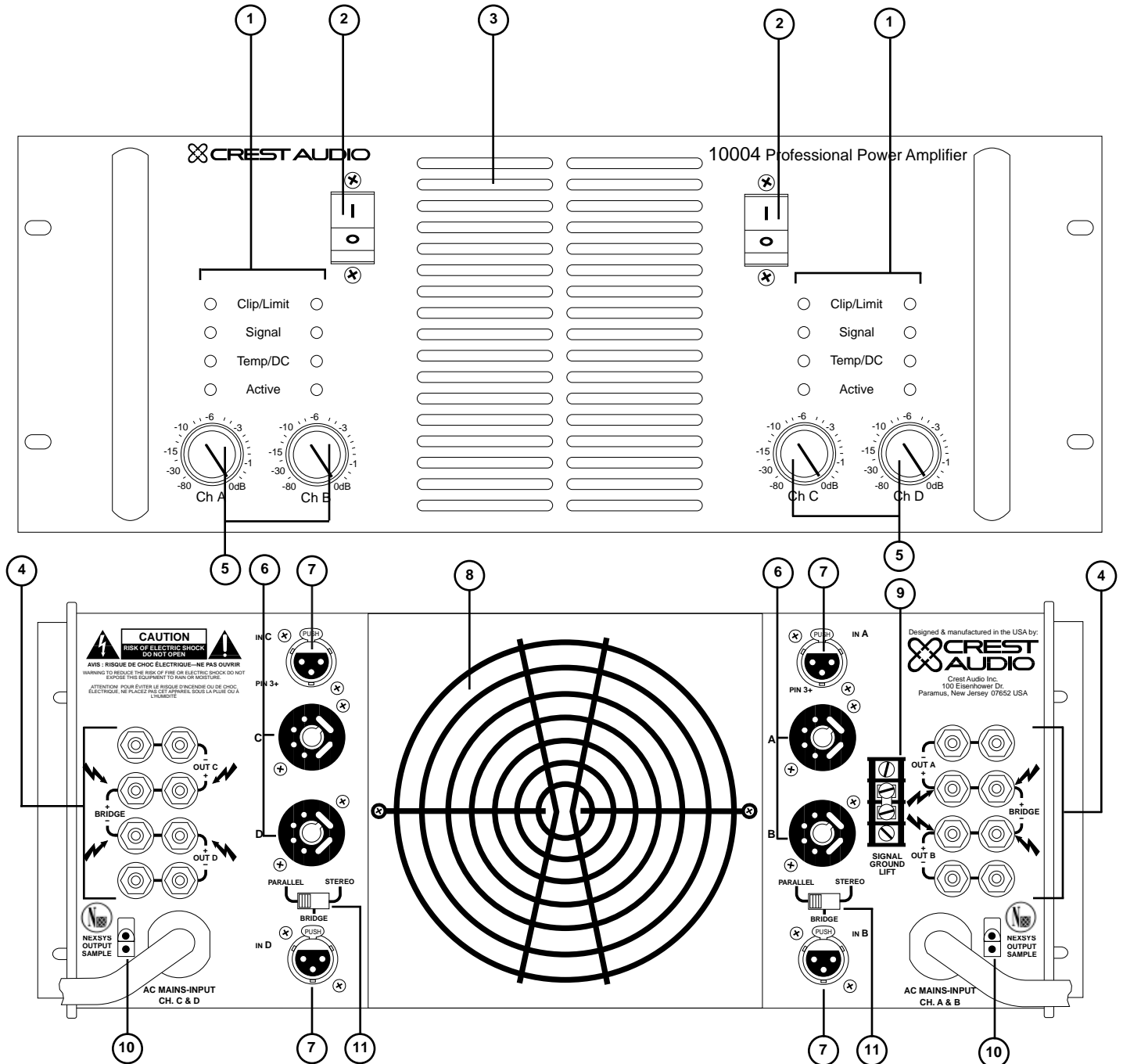

- 1-Front Panel Channel Clip/Limit, Signal, Temp/DC, and Active LEDs. 2-Combination Circuit Breaker/Power Switches.
- 3-Heated Air Exhaust Grill. 4-Five-Way Output Binding Post Connectors. 5-Channel Attenuators. 6-Crest Audio Octal Socket Accessory Connectors. 7-XLR input connectors. 8-Air Intake/Fan Filter. 9-Signal Ground Lift Barrier Strip.
- 10-NexSys Output Sample Connector. 11-Mode Select Switch

Connecting Inputs

Input connections are made via the 3-pin XLR connectors (pin 3+) on the rear panel of the amplifier. The inputs are actively balanced. Pinout and polarity of connection cables should be configured as shown at the right. The input overload point is high enough to accept the maximum output level of virtually any signal source. All models have two input connections; the exception being Model 10004, which has four.

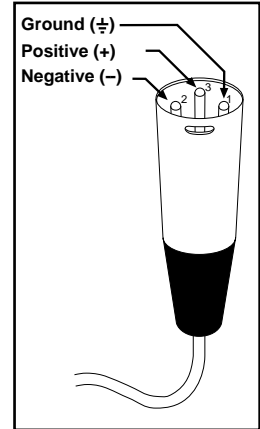

XLR Pinouts

Connecting Outputs

On the models 9001 and 10001, speaker cables must be connected to the single screw solderless lug connectors on the back of the amplifiers. For all other models, speaker cables can be connected with banana plugs, spade lugs, or bare wire to the 5-way binding posts. On the Models 8001 and 10004, two pairs of 5-way binding posts are provided for each channel, so that paralleling of speakers is possible. Consult the Wire Gauge Chart to find a suitable wire gauge to minimize losses of power and damping factor in the cables.

Note: See the section on model 7301 for pertinent output connection information.



Never connect a “hot” (red) output to ground or to another “hot” (red) output! Always turn off the amplifier before making connections.

Octal Accessory Sockets

Professional Series amplifiers have two octal accessory sockets on the back panel that provide convenient insertion points for accessories in the signal path between the mode switch and the preamps. Some of the available Octal Socket Accessories include the Crest Audio XO-2 24 dB/Octave Crossover, LX-2.2 24 dB/Octave Crossover with Limiter, LM-1 Limiter, LM-2.2 Dual Limiter, PA-1 Precision Attenuator, CDEQ-2 Constant Directivity Horn Compensation Filter, or the TX-1 Input Isolation Transformer. To use the accessory sockets, first remove the factory-installed jumpers. The list below indicates the socket pinouts:

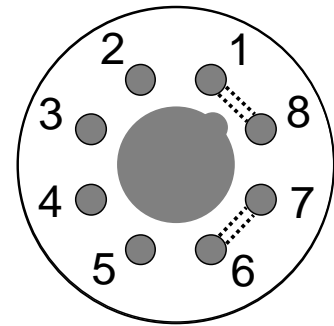

Octal Pinouts

Pin	Channel A	Channel B
1	Ch. A(-) Inverting Signal Return	Ch. B (-) Inverting Signal Return
2	Ground*	Same as Ch. A*
3	Reserved	Reserved
4	+24VDC @ 25mA	-Vcc High Voltage (Unregulated)
5	+24VDC (Regulated)	+24VDC (Regulated)
6	Ch. A (+) Non-inverting Signal Return	Ch. B (+) Non-inverting Signal Return
7	Ch. A (+) Non-inverting Signal Send§	Ch. B (+) Non-inverting Signal Send
8	Ch. A (-) Inverting Signal Send	Ch. B (-) Inverting Signal Send

* From input ground; reference ground for DC voltages at octal pins 4 - 5.

§ From Ch. A (+) non-inverting input.

For normal operation (not using the accessory sockets), jump Pin 1 to Pin 8 and Pin 6 to Pin 7 on both sockets (indicated by the dotted lines in Figure 7; the jumpers are set this way at the factory). To invert the input polarity, that is, to make XLR Pin 2 (+) and Pin 3 (-), remove the existing jumpers and jump Pin 1 to Pin 7 and Pin 6 to Pin 8. If the jumpers are misplaced, use solid wire; 4mm² (metric) or No. 10 (AWG) will suffice. If the wire is too small, it will not fit snugly in the socket holes and may fall out; if it is too large, it may distort the socket contacts.

NexSys

Professional Series amplifiers are compatible with NexSys, Crest Audio’s dynamic hardware/software package that allows for sound system control and management from a Windows-based PC. The octal socket is used to connect between the amplifier and the NexSys supervisor via the NS-CCM-2 Control Module.

Connecting Power

Professional Series power amplifier power requirements are rated at:

- a) "idle"
- b) 1/8th power ("typical" music conditions)
- c) 1/3rd power ("continuous" music conditions)
- d.) maximum rated power.



Never try to hold the power switch in the "ON" position if it won't stay there itself! Always turn off the amplifier before changing operating modes!

The maximum power current draw rating is limited only by the front panel circuit breaker. Consult the specifications in the *Appendices* section for figures on the current that each amplifier will demand. Make sure the mains voltage is correct and is the same as that printed on the rear of the amplifier. Damage caused by connecting the amplifier to improper AC voltage is not covered by any warranty. Unless otherwise specified when ordered, Crest amplifiers shipped to customers are configured as follows:

North America	-	120VAC / 60Hz
Europe	-	230VAC / 50Hz
Asia	-	220VAC / 50Hz
Australasia	-	240VAC / 50Hz
South America	-	120VAC / 60Hz or 220VAC / 50Hz
Japan	-	100VAC / 50Hz

NOTE: Always turn off and disconnect the amplifier from mains voltage before making audio connections. Also, as an extra precaution, have the attenuators turned down during power-up.

Operation Modes

Stereo Operation

For stereo (dual channel) operation, turn the amplifier off and set the mode select switch to the stereo position. In this mode, both channels operate independently of each other, with their input attenuators controlling their respective levels. Thus, a signal at Channel A's input produces an amplified signal at Channel A's output, while a signal at Channel B's input produces an amplified signal at Channel B's output. For models 9001 and 10004, the recommended minimum nominal load impedance for stereo or parallel operation is 2Ω per channel. For model 10001, the minimum is 1 ohm per channel. *Note: The Model 7301 has no mode select switch; it always operates as a dual-channel amplifier. Model 10004 has two mode select switches, one for channels A/B, and one for channels C/D.*

Parallel Operation

For parallel (dual-channel/single input) operation, turn the amplifier off and set the mode switch in the parallel position; both amplifier channels are then driven by the signal at Channel A's input. No jumper wires are needed. Output connections are the same as in the stereo mode. In the parallel mode, only Channel A's input is active; Channel B's is out-of-circuit. Both input attenuators remain active, allowing you to set different levels for each channel. Power and other general performance specifications are the same as in the stereo mode. *Note: Model 7301 has no mode select switch; it always operates as a dual-channel amplifier.*

Bridged Mono Operation

Both amplifier channels can be bridged together to make a very powerful single-channel monaural amplifier. Use extreme caution when operating in the bridged mode; potentially lethal voltage may be present at the output terminals. To bridge the amplifier, set the rear panel mode select switch to the bridge position. Apply the signal to Channel A's input and connect the speakers across the hot outputs (the "+" binding posts of Channels A and B).

Unlike the stereo and parallel modes, in which one side of each output is at ground, in the bridged mode both sides are hot. Channel A's side is in phase with the input. For proper operation, both input attenuators must be in the same position. This keeps the load balanced between the channel outputs. As in the parallel mode, only Channel A's input is active. *Note: The Model 7301 cannot operate in bridged mono mode; it always operates as a dual-channel amplifier. See the separate section on this model.*

Bridged Mono Operation - Model 10004

The Model 10004 power amplifier is configured so that one or both pairs of channels can be bridged to mono. Using the rear panel mode select switches, follow the same procedures as outlined above to bridge channels A&B together and/or C&D together.

Bridging Precautions

Use extreme caution when operating the amplifier in the bridged mode; as potentially lethal voltage may be present at the output terminals. Never ground either side of the speaker cable when the amplifier is in the bridged mode; both sides are hot. If an output patch panel is used, all connections must be isolated from each other and from the panel. The recommended minimum nominal load impedance in the bridged mode is 4Ω (equivalent to driving both channels at 2Ω). Driving bridged loads of less than 4Ω will activate the IGM circuitry resulting in a loss of power, and may also cause a thermal overload.



Connecting amplifier outputs to oscilloscopes or other test equipment while the amplifier is in bridged mode may damage both the amplifier and test equipment!

Switches & Controls

AC Power Switch/Circuit Breaker

The Professional Series amplifiers have a combination AC switch/circuit breaker on the front panel. If the switch shuts off during normal use, push it back to the ON position once. If it will not stay on, the amplifier needs servicing. The 10001 has two AC switch/circuit breakers (one for each channel); the 10004 has two, one for each twin-channel amp.

Input Attenuators

Whenever possible, set the attenuators fully clockwise to maintain optimum system headroom. The input attenuator controls (one for channel A, one for channel B) located at the front panel adjust gain for their respective amplifier channels in all modes. See the specifications at the end of this manual for standard voltage gain and input sensitivity information.

When operating a Professional Series amplifier in the bridged mode, both attenuators must be in the same position so the speaker load will be equally shared between the channels. See the section on Bridged Mono Operation for more information and precautions.

Note: on the Model 7301, channel attenuators are labeled "LOWS" and "HIGHS", corresponding to the low and high frequency monitor output channels.

Mode Select Switch

The rear panel Mode Select Switch determines whether the amplifier is in the stereo, parallel, or bridged mono mode. Do not operate the Mode Select Switch with the amplifier powered on. See the sections on Stereo and Bridged Mono Mode for more information.

Note: On the 10004 model, there are two Mode Select Switches on the rear panel. The Model 7301 power amplifier does not have a Mode Select Switch. For more information, see the Model 7301 section.

Signal Ground Lift Jumper

In a properly designed system (for safety and to minimize noise), the amplifier should receive its ground from the AC line cord. Whenever possible, the signal source equipment should share the same AC ground as the amplifier(s). In some cases, however, this may result in a ground loop. If this happens, remove the ground lift jumper (supplied) on the rear barrier strip. This jumper electrically connects the signal ground (Pin 2) to the chassis/AC ground (Pin 1). If the jumper is removed, the signal ground is lifted and completely isolated from the chassis/AC ground. Do not remove the jumper if the amplifier and the signal source equipment are not on the same AC ground.

Note: On the Model 10004 power amplifier, there are two (2) signal ground lift jumpers.

Indicators

Professional Series amplifiers feature four front panel LED indicators per channel: Clip/Limit, Signal, Temp/DC, and Active. These LED indicators inform the user of each channel's operating status and warn of possible abnormal conditions.

Clip/Limit LED

A channel's Clip/Limit LED will light dimly at the onset of clipping and increase in brilliance as clipping becomes more severe, staying on until the clipping ceases. If the LED's are flashing quickly and intermittently, the channel is just at the clip threshold, while a steady, bright glow means the amp is clip limiting, or reducing gain to prevent severely clipped waveforms reaching the loudspeakers. See the Clip Limiting section for more information.

Signal LED

This LED lights when its channel produces an output signal of about 4 volts RMS or more (0.1 volt or more at the input, with 0 dB attenuation and standard X40 voltage gain). It is useful in determining whether a signal is reaching and being amplified by the amplifier.

Temp/DC LED

The Temp/DC LED lights to indicate that the channel's output relay is open, disconnecting the speaker(s) for any of the following reasons:

1. The unit was just powered up and is in the turn-on delay mode.
2. The amplifier senses a DC voltage at its output.
3. The channel has overheated.

Active LED

The Active LED indicates that its channel's output relay is closed and the channel is operational. It lights under normal operation and remains on even when the channel is in clip limiting or IGM gain reduction. These are protection features which leave the output relay closed. If the Active LED goes off, there is no signal at the module output point.

Protection Features

Professional Series amplifiers incorporate several circuits to protect both themselves and loudspeakers under virtually any situation. Crest Audio has attempted to make the amplifiers as foolproof as possible by making them immune to short and open circuits, mismatched loads, DC voltage, and overheating. If a channel goes into the clip limiting or IGM gain reduction mode, the speaker load remains connected, but clipping percentage or output power are instantly reduced. When a problem occurs that causes a channel to go into a protection mode, the Temp/DC LED for that channel will glow. DC voltage on the output, excessive subsonic frequencies, or thermal overload will cause the channel's output relay to disconnect the speaker load until the problem is corrected or the amplifier cools down.

Clip Limiting

Any time a channel is driven into hard, continuous clipping, the clip limiter circuit will automatically reduce the channel gain to a level just slightly into clipping, guarding the speakers against the damaging high power continuous square waves that may be produced. Situations that may activate the clip limiter include uncontrolled feedback, oscillations, or an improper equipment setting or malfunction upstream from the amplifier. Normal program transients will not trigger the clip limiter; only steady, excessive clipping will. The Clip/Limit LED will glow brightly and continuously when limiting occurs.

IGM Impedance Sensing

Professional Series amplifiers feature innovative circuitry that allows safe operation into any load. When an amplifier sees a load that overstresses the output stage, the Instantaneous Gain Modulation (IGM) circuit adjusts the channel gain to a safe level. This method of output stage protection is far superior to conventional, brute force type limiting found on other amplifiers. Like the clip limiter, the IGM circuit is sonically transparent in normal use and unobtrusive when activated.

Thermal Protection

The internal fan(s) will keep the amplifier operating well within its intended temperature range under all normal conditions. If a channel's heat sink temperature reaches 75°C, (85°C for Models 7001 and 8001) which may indicate an obstructed air supply, clogged air filter, etc., that channel will independently protect itself by disconnecting its load and shutting down until it has cooled to 72°C (82°C for Models 7001 and 8001). During this time, the channel's DC/Temp LED will light. If the power transformer gets too hot, its thermal sensing circuit will disconnect both channel outputs. Normal operation will resume automatically once the transformer cools to a safe level. During this time, the Active LED will extinguish, the Temp/DC and Clip/Limit LED's will stay lit, and the cooling fan will stay running.

Short Circuit

If an output is shorted, the IGM and thermal circuits will automatically protect the amplifier. The IGM circuit senses the short circuit as an extremely stressful load condition and attenuates the signal, protecting the channel's output transistors from overcurrent stress. If the short circuit remains, the channel will eventually thermally protect itself by disconnecting the load.

DC Voltage Protection

If an amplifier channel detects DC voltage at its output terminals, its output relay will immediately open to prevent loudspeaker damage. The channel's Temp/DC LED will light.

Subsonic Frequencies

The Professional Series amplifiers have built-in 12 dB per octave high-pass filtering, cornered at 8 Hz, to provide subsonic frequency protection for each channel. In addition, a channel's output relay will open if excessive subsonic energy appears at the output.

Turn-On/Turn-Off Protection

At power-up, the amplifier stays in the protect mode, with outputs disconnected, for about 3 seconds while the power supplies charge and stabilize. While the output relays are open, the Temp/DC LED's light. When power is removed, the speaker loads immediately disconnect so that no thumps or pops are heard.

AutoRamp Signal Control

Whenever a Professional Series amplifier powers up or comes out of a protect mode, the AutoRamp circuit activates. While the speakers are disconnected, the AutoRamp circuit fully attenuates the signal. After the output relay closes, the signal slowly and gradually raises up to its set level. The AutoRamp Signal Control circuit has some important advantages over the conventional instant-on circuits:

1. If a signal is present during power-up (or when coming out of protect), the speakers are spared a sudden, potentially damaging burst of audio power.
2. Because the gain is reduced until after the output relay closes, no arcing occurs at the contacts, thereby extending their useful life.

Speaker Protection

All loudspeakers have electrical, thermal, and physical limits which must be observed to prevent damage or failure. Too much power, low frequencies applied to high frequency drivers, severely clipped waveforms, and DC voltage can all be fatal to cone and compression drivers. The Crest Audio Professional Series amplifiers automatically protect speakers from DC voltages and subsonic signals. For more information, see the section on Protection Features. Mid- and high-frequency speakers, especially compression drivers, are highly susceptible to damage from overpowering, clipped waveforms, or frequencies below their rated passband. Be extremely careful that the low and mid bands of an electronic crossover are connected to the correct amplifiers and drivers and not accidentally connected to those for a higher frequency band. The amplifier's clipping point is its maximum peak output power, and some of the higher power Crest Audio Professional Series amplifiers can deliver more power than many speakers can safely handle. Be sure the peak power capability of the amplifier is not excessive for your speaker system.

To ensure that the speakers never receive excessive power and that the amplifier never clips, use a properly adjusted external limiter (or a compressor with a ratio of 10:1 or higher) to control power output; in systems with active electronic crossovers, use one for each frequency band. The clip limiter will automatically limit the duration of squared-off, continuous waveforms applied to the speakers. The amplifier will, however, allow normal musical transient bursts to pass. Of course, when the amplifier does clip, it is right at its maximum output power. Some speaker systems are packaged with processors that have power limiting circuits and should not require additional external limiting. Fuses may also be used to limit power to speaker drivers, although as current-limiting rather than voltage-limiting devices, they are an imperfect solution, and as the weakest links, they only limit once before needing replacement. Some poor quality fuses have a significant series resistance that could degrade the amplifier's damping of the speaker's motion and may even deteriorate the system's sound quality. If you elect to use fuses, check with the speaker manufacturer to determine the proper current rating and time lag required.

Do not drive any low-frequency speaker enclosure with frequencies lower than its own tuned frequency; the reduced acoustical damping could cause a ported speaker to bottom out even at moderate power. Consult the speaker system specifications to determine its frequency limits.



Use common sense...

it's the most important facet of any speaker protection scheme.

Amplifier Maintenance and User Responsibility

If you use the air filter supplied with your Professional Series amplifier, the filter element must be cleaned or replaced periodically to maintain adequate airflow. How often you must do this depends on the environment in which you operate the amplifier. A very dusty environment will necessitate a shorter service interval than a less dirty one. To clean the element, unsnap the filter element/guard assembly from the fan housing, and remove the filter element. On two-piece guards, pry the two sides apart to remove the element. Wash and rinse the element using soap and water, then squeeze it dry and reinstall. Instead of cleaning, you may also cut a replacement element from a sheet of air conditioner foam filter material, using the old element as a pattern. Never operate an amplifier with a clogged filter; it will quickly overheat. Replacement filter elements and element/guard assemblies can also be ordered from Crest Audio. A Professional Series amplifier requires no other routine maintenance and should never need any internal adjustment during its lifetime. Your Professional Series amplifier is very powerful and can be potentially dangerous to loudspeakers and humans alike. It is your responsibility to read the Important Precautions section and to make sure that the amplifier is installed, wired, and operated properly as instructed in this manual. Many loudspeakers can be easily damaged or destroyed by overpowering, especially with the high power available from a bridged amplifier. Read the Speaker Protection section and always be aware of the speaker's continuous and peak power capabilities.

Service / Warranty Information

In the unlikely event that your amplifier develops a problem, it must be returned to an authorized distributor, service center or shipped directly to our factory. To obtain service, contact your nearest Crest Audio Service Center, Distributor, Dealer, or any of the worldwide Crest Audio offices. For contact information, reach Crest Audio Inc. Customer Service directly at: TEL 201.909.8700 (USA) FAX 201.909.8744 (USA). *For technical inquiries only, the Crest Audio Technical Services department can be faxed at 201.587.0550 (USA).*

Because of the complexity of the design and the risk of electrical shock, all repairs should be attempted only by qualified technical personnel. If the unit needs to be shipped back to the factory, it must be sent in its original carton. If improperly packed, your amplifier may be damaged.

For those with Internet access, please visit the Crest Audio website at: <http://www.crestaudio.com>

Appendix A - Professional Series Block Diagram

The block diagram shown is accurate for all the Professional Series amplifiers.
(The Model 10004 amplifier has four channels arranged in two pairs.)

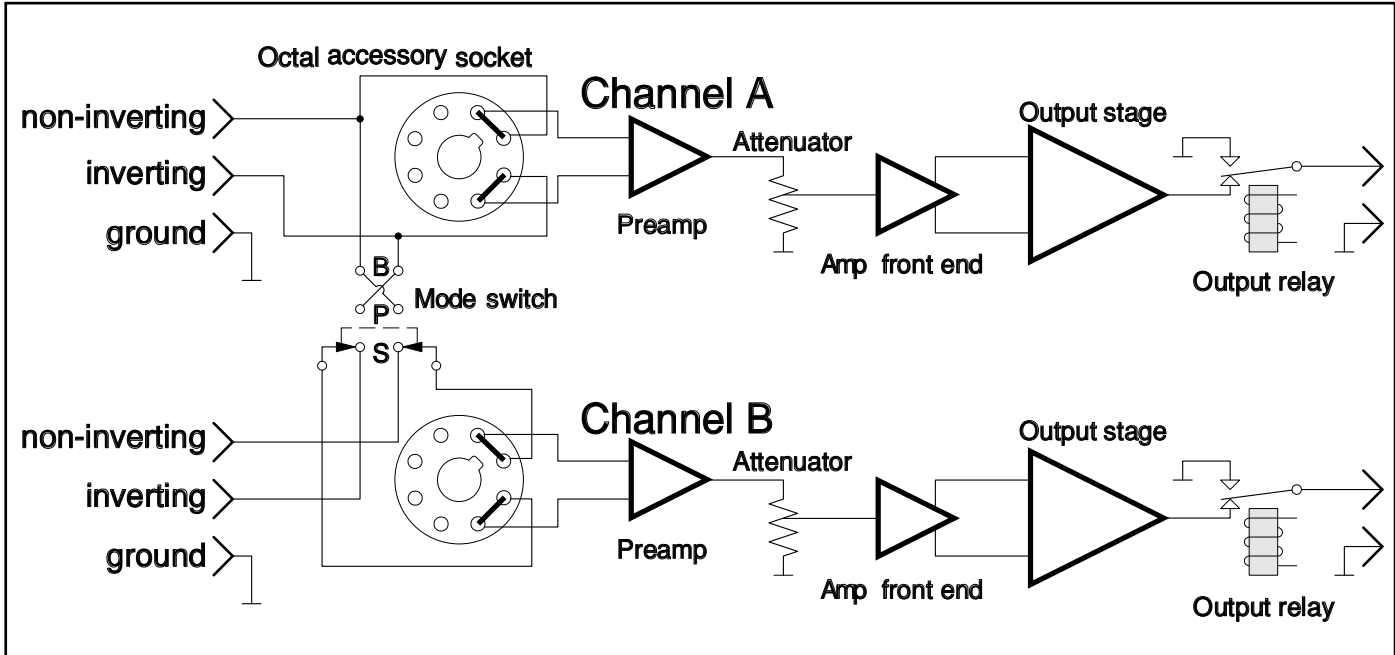

Appendix B - General Amplifier Specifications (Model 3301)

	1kHz, <0.025% THD+N	20Hz-20kHz, <0.1% THD+N
8Ω Stereo Power	240W	220W
4Ω Stereo Power	380W	330W
2Ω Stereo Power	425W	400W
8Ω Bridged Mono Power	725W	660W
4Ω Bridged Mono Power	830W	800W
Max RMS Output Voltage (each channel)	49V	
Peak Output Voltage (each channel)	69V	
Frequency Response (+0 / -0.3dB, 1W/8Ω)	20 Hz-20 kHz, -3dB @ 53kHz	
Power Bandwidth (rated power at 4Ω, 1% THD+N)	20 Hz-20 kHz, +0/-0.2dB	
Protection Circuitry	Clip Limit, IGM, AutoRamp, High Temp, short-circuit, DC voltage, turn-on/off transient, sub/ultrasonic input.	
THD+N (rated power at 4Ω, 1kHz)	<0.025%	
SMPTE IMD (rated power at 8Ω, 60Hz & 7kHz)	<0.1%	
Damping Factor (10-400Hz at 8Ω)	400:1	
Input CMRR (1kHz)	>60 dB	
Input Sensitivity (rated power at 4Ω)	0.908V RMS	
Voltage Gain	X40	
Input Impedance (balanced)	>20kΩ	
Hum and Noise ("A" weighted, full power, 4Ω)	> -100 dB	
Crosstalk ("A" weighted, full power, 4Ω)	> -60dB	
Class	AB	
Input Connectors (per channel)	Female XLR (pin 3+), Octal Socket	
Output Connectors (per channel)	5-way output binding posts	
Filter Storage	29,200 μF	
Standard Power Supply (USA)	120V, 60Hz	
Idle Current Draw (120V)	1.0A	
1/8 Power Curr. Draw (typical music, 120V/4Ω)	6.25A	
1/3 Power Curr. Draw (continuous music, 120V/4Ω)	9.0A	
Max Curr. Draw (circuit breaker rating, 120V/4Ω)	11.0A	
Thermal Emissions (1/8 Power, 4Ω)	2235 BTU/hr	
Thermal Emissions (1/3 Power, 4Ω)	2821 BTU/hr	
Cooling	Rear to front tunnel heatsink, variable speed DC fan	
Controls	Front panel: 2 attenuators, circuit breaker/power switch; Rear panel: mode switch, signal ground lift jumper.	
LED Indicators (per channel)	Clip/Limit, Signal, Temp/DC, Active	
Construction	16 ga. single piece steel chassis, .187" (5mm) alum. front panel	
Dimensions (Height x Width x Depth)	3.5"x19"x15" (16" to rear ears) 89mm x 483mm x 381mm (406mm to rear ears)	
Gross Weight, Net Weight	47.0 lbs (21.34 kg.), 42.0 lbs (19.07 kg.)	
Warranty	5 years, parts and labor†	

† USA, Canada, U.K., and many other countries. Power figures are watts per channel, both channels driven. Crest Audio reserves the right to make improvements in manufacturing or design which may affect specifications. Crest Audio specification literature is available in downloadable PDF file format; visit our website at <http://www.crestaudio.com>. ©1997 Crest Audio Inc. 12/15/97

Appendix B - General Amplifier Specifications (Model 4601)

	1kHz, <0.012% THD+N	20Hz-20kHz, <0.05% THD+N
8Ω Stereo Power	350W	300W
4Ω Stereo Power	485W	425W
8Ω Bridged Mono Power	925W	825W
Max RMS Output Voltage (each channel)	59V	
Peak Output Voltage (each channel)	83.4V	
Frequency Response (+0 / -0.3dB, 1W/8Ω)	20 Hz-20 kHz, -3dB @ 53kHz	
Power Bandwidth (rated power at 4Ω, 1% THD+N)	20 Hz-20 kHz, +0/-0.2dB	
Protection Circuitry	Clip Limit, IGM, AutoRamp, High Temp, short-circuit, DC voltage, turn-on/off transient, sub/ultrasonic input.	
THD+N (rated power at 4Ω, 1kHz)	<0.012%	
SMPTE IMD (rated power at 8Ω, 60Hz & 7kHz)	<0.1%	
Damping Factor (10-400Hz at 8Ω)	400:1	
Input CMRR (1kHz)	>60 dB	
Input Sensitivity (rated power at 4Ω)	1.03V RMS	
Voltage Gain	X40	
Input Impedance (balanced)	>20kΩ	
Hum and Noise ("A" weighted, full power, 4Ω)	> -100 dB	
Crosstalk ("A" weighted, full power, 4Ω)	> -60dB	
Class	AB	
Input Connectors (per channel)	Female XLR (pin 3+), Octal Socket	
Output Connectors (per channel)	5-way output binding posts	
Filter Storage	40,800 μF	
Standard Power Supply (USA)	120V, 60Hz	
Idle Current Draw (120V)	1.1A	
1/8 Power Curr. Draw (typical music, 120V/4Ω)	7.3A	
1/3 Power Curr. Draw (continuous music, 120V/4Ω)	11.1A	
Max Curr. Draw (circuit breaker rating, 120V/4Ω)	18.0A	
Thermal Emissions (1/8 Power, 4Ω)	2576 BTU/hr	
Thermal Emissions (1/3 Power, 4Ω)	3443 BTU/hr	
Cooling	Rear to front tunnel heatsink, 2 variable speed DC fans	
Controls	Front panel: 2 attenuators, circuit breaker/power switch; Rear panel: mode switch, signal ground lift jumper.	
LED Indicators (per channel)	Clip/Limit, Signal, Temp/DC, Active	
Construction	16 ga. single piece steel chassis, .187" (5mm) alum. front panel	
Dimensions (Height x Width x Depth)	3.5"x19"x15" (16" to rear ears) 89mm x 483mm x 381mm (406mm to rear ears)	
Gross Weight, Net Weight	48.0 lbs (21.79 kg.), 43.0 lbs (19.52 kg.)	
Warranty	5 years, parts and labor†	

† USA, Canada, U.K., and many other countries. Power figures are watts per channel, both channels driven. Crest Audio reserves the right to make improvements in manufacturing or design which may affect specifications. Crest Audio specification literature is available in downloadable PDF file format; visit our website at <http://www.crestaudio.com>. ©1997 Crest Audio Inc. 12/15/97

Appendix B - General Amplifier Specifications (Model 4801)

	1kHz, <0.025% THD+N	20Hz-20kHz, <0.05% THD+N
8Ω Stereo Power	400W	300W
4Ω Stereo Power	575W	480W
8Ω Bridged Mono Power	1150W	960W
2Ω Stereo Power	700W	600W
4Ω Bridged Mono Power	1300W	1200W
Max RMS Output Voltage (each channel)	60V	
Peak Output Voltage (each channel)	85V	
Frequency Response (+0 / -0.3dB, 1W/8Ω)	20 Hz-20 kHz, -3dB @ 53kHz	
Power Bandwidth (rated power at 4Ω, 1% THD+N)	20 Hz-20 kHz, +0/-0.2dB	
Protection Circuitry	Clip Limit, IGM, AutoRamp, High Temp, short-circuit, DC voltage, turn-on/off transient, sub/ultrasonic input.	
THD+N (rated power at 4Ω, 1kHz)	<0.025%	
SMPTE IMD (rated power at 8Ω, 60Hz & 7kHz)	<0.1%	
Damping Factor (10-400Hz at 8Ω)	400:1	
Input CMRR (1kHz)	>60 dB	
Input Sensitivity (rated power at 4Ω)	1.1V RMS	
Voltage Gain	X40	
Input Impedance (balanced)	>20kΩ	
Hum and Noise ("A" weighted, full power, 4Ω)	> -100 dB	
Crosstalk ("A" weighted, full power, 4Ω)	> -60dB	
Class	Class H	
Input Connectors (per channel)	Female XLR (pin 3+), Octal Socket	
Output Connectors (per channel)	5-way output binding posts	
Filter Storage	80,000 μF	
Standard Power Supply (120V)	120V, 60Hz	
Idle Current Draw (120V)	1.1A	
1/8 Power Curr. Draw (typical music, 120V/4Ω)	5.6A	
1/3 Power Curr. Draw (continuous music, 120V/4Ω)	11.46	
Max Curr. Draw (circuit breaker rating, 120V/4Ω)	18.0A	
Thermal Emissions (1/8 Power, 4Ω)	1803 BTU/hr	
Thermal Emissions (1/3 Power, 4Ω)	3385 BTU/hr	
Cooling	Rear to front tunnel heatsink, variable speed DC fan	
Controls	Front panel: 2 attenuators, circuit breaker/power switch; Rear panel: mode switch, signal ground lift jumper.	
LED Indicators (per channel)	Clip/Limit, Signal, Temp/DC, Active	
Construction	16 ga. single piece steel chassis, .187" (5mm) alum. front panel	
Dimensions (Height x Width x Depth)	3.5"x19"x15" (16" to rear ears) 89mm x 483mm x 381mm (406mm to rear ears)	
Gross Weight, Net Weight	54.0 lbs (24.52 kg.), 49.0 lbs (22.25 kg.)	
Warranty	5 years, parts and labor†	

† USA, Canada, U.K., and many other countries. Power figures are watts per channel, both channels driven. Crest Audio reserves the right to make improvements in manufacturing or design which may affect specifications. Crest Audio specification literature is available in downloadable PDF file format; visit our website at <http://www.crestaudio.com>. ©1997 Crest Audio Inc. 12/15/97

Appendix B - General Amplifier Specifications (Model 6001)

	1kHz, <0.025% THD+N	20Hz-20kHz, <0.05% THD+N
8Ω Stereo Power	430W	400W
4Ω Stereo Power	700W	600W
2Ω Stereo Power	800W	720W
8Ω Bridged Mono Power	1320W	1200W
4Ω Bridged Mono Power	1500W	1440W
Max RMS Output Voltage (each channel)	70V	
Peak Output Voltage (each channel)	99V	
Frequency Response (+0 / -0.3dB, 1W/8Ω)	20 Hz-20 kHz, -3dB @ 53kHz	
Power Bandwidth (rated power at 4Ω, 1% THD+N)	20 Hz-20 kHz, +0/-0.2dB	
Protection Circuitry	Clip Limit, IGM, AutoRamp, High Temp, short-circuit, DC voltage, turn-on/off transient, sub/ultrasonic input.	
THD+N (rated power at 4Ω, 1kHz)	<0.025%	
SMPTE IMD (rated power at 8Ω, 60Hz & 7kHz)	<0.1%	
Damping Factor (10-400Hz at 8Ω)	400:1	
Input CMRR (1kHz)	>60 dB	
Input Sensitivity (rated power at 4Ω)	1.2V RMS	
Voltage Gain	X40	
Input Impedance (balanced)	>20kΩ	
Hum and Noise ("A" weighted, full power, 4Ω)	> -100 dB	
Crosstalk ("A" weighted, full power, 4Ω)	> -60dB	
Class	H	
Input Connectors (per channel)	Female XLR (pin 3+), Octal Socket	
Output Connectors (per channel)	5-way output binding posts	
Filter Storage	120,000 μF	
Standard Power Supply (USA)	120V, 60Hz	
Idle Current Draw (120V)	1.1A	
1/8 Power Curr. Draw (typical music, 120V/4Ω)	5.96A	
1/3 Power Curr. Draw (continuous music, 120V/4Ω)	13.26A	
Max Curr. Draw (circuit breaker rating, 120V/4Ω)	21A	
Thermal Emissions (1/8 Power, 4Ω)	1844 BTU/hr	
Thermal Emissions (1/3 Power, 4Ω)	3838 BTU/hr	
Cooling	Rear to front tunnel heatsink, variable speed DC fan	
Controls	Front panel: 2 attenuators, circuit breaker/power switch; Rear panel: mode switch, signal ground lift jumper.	
LED Indicators (per channel)	Clip/Limit, Signal, Temp/DC, Active	
Construction	16 ga. single piece steel chassis, .187" (5mm) alum. front panel	
Dimensions (Height x Width x Depth)	3.5"x19"x15" (16" to rear ears) 89mm x 483mm x 381mm (406mm to rear ears)	
Gross Weight, Net Weight	56.0 lbs. (25.42 kg.), 51.0 lbs. (23.10 kg.)	
Warranty	5 years, parts and labor†	

† USA, Canada, U.K., and many other countries. Power figures are watts per channel, both channels driven. Crest Audio reserves the right to make improvements in manufacturing or design which may affect specifications. Crest Audio specification literature is available in downloadable PDF file format; visit our website at <http://www.crestaudio.com>. ©1997 Crest Audio Inc. 12/15/97

Appendix B - General Amplifier Specifications (Model 7001)

	1kHz, <0.02% THD+N	20Hz-20kHz, <0.05% THD+N
8Ω Stereo Power	560W	550W
4Ω Stereo Power	810W	715W
8Ω Bridged Mono Power	1650W	1510W
2Ω Stereo Power	850W	850W
4Ω Bridged Mono Power	1700W	1600W
Max RMS Output Voltage (each channel)	83V	
Peak Output Voltage (each channel)	117V	
Frequency Response (+0 / -0.3dB, 1W/8Ω)	20 Hz-20 kHz, -3dB @ 53kHz	
Power Bandwidth (rated power at 4Ω, 1% THD+N)	20 Hz-20 kHz, +0/-0.2dB	
Protection Circuitry	Clip Limit, IGM, AutoRamp, High Temp, short-circuit, DC voltage, turn-on/off transient, sub/ultrasonic input.	
THD+N (rated power at 4Ω, 1kHz)	<0.02%	
SMPTE IMD (rated power at 8Ω, 60Hz & 7kHz)	<0.1%	
Damping Factor (10-400Hz at 8Ω)	400:1	
Input CMRR (1kHz)	>60 dB	
Input Sensitivity (rated power at 4Ω)	1.4V RMS	
Voltage Gain	X40	
Input Impedance (balanced/unbalanced)	>20kΩ/10kΩ	
Hum and Noise ("A" weighted, full power, 4Ω)	> -100 dB	
Crosstalk ("A" weighted, full power, 4Ω)	> -60dB	
Class	H	
Input Connectors (per channel)	Female XLR (pin 3+), Octal Socket	
Output Connectors (per channel)	5-way output binding posts	
Filter Storage	80,000 μF	
Standard Power Supply (USA)	120V, 60Hz	
Idle Current Draw (120V)	1.4A	
1/8 Power Curr. Draw (typical music, 120V/4Ω)	7.8A	
1/3 Power Curr. Draw (continuous music, 120V/4Ω)	15.5A	
Max Curr. Draw (circuit breaker rating, 120V/4Ω)	21.0A	
Thermal Emissions (1/8 Power, 4Ω)	2503 BTU/hr	
Thermal Emissions (1/3 Power, 4Ω)	4505 BTU/hr	
Cooling	Rear to front tunnel heatsink, 2 variable speed DC fans	
Controls	Front panel: 2 attenuators, circuit breaker/power switch; Rear panel: mode switch, signal ground lift jumper.	
LED Indicators (per channel)	Clip/Limit, Signal, Temp/DC, Active	
Construction	16 ga. single piece steel chassis, .187" (5mm) alum. front panel	
Dimensions (Height x Width x Depth)	3.5"x19"x15" (16" to rear ears) 89mm x 483mm x 381mm (406mm to rear ears)	
Gross Weight, Net Weight	57 lbs. (25.88 kg.), 52 lbs. (23.60 kg.)	
Warranty	5 years, parts and labor†	

† USA, Canada, U.K., and many other countries. Power figures are watts per channel, both channels driven. Crest Audio reserves the right to make improvements in manufacturing or design which may affect specifications. Crest Audio specification literature is available in downloadable PDF file format; visit our website at <http://www.crestaudio.com>. ©1997 Crest Audio Inc. 12/15/97

Appendix B - General Amplifier Specifications (Model 7301)

	Lows @ 100Hz, <0.1% THD+N	Highs @ 1kHz, <0.05% THD+N
Both Channels @ 4Ω	940W	240W
Lows @ 2Ω, Highs @ 4Ω	990W	220W
Lows @ 4Ω, Highs @ 8Ω	940W	125W
Lows @ 8Ω, Highs @ 16Ω	670W	95W
Max RMS Output Voltage (each channel)	83V(Low Ch.) 49V(High Ch.)	
Peak Output Voltage (each channel)	117V(Low Ch.) 69V(High Ch.)	
Frequency Response (+0 / -0.3dB, 1W/8Ω)	20 Hz-20 kHz, -3dB @ 53kHz	
Power Bandwidth (rated power at 4Ω, 1% THD+N)	20 Hz-20 kHz, +0/-0.2dB	
Protection Circuitry	Clip Limit, IGM, AutoRamp, High Temp, short-circuit, DC voltage, turn-on/off transient, sub/ultrasonic input.	
THD+N (rated power at 4Ω, 1kHz)	<0.02% @ 800W (Low Ch.); 200W (High Ch.)	
Damping Factor (10-400Hz at 8Ω)	400:1	
Input CMRR (1kHz)	>60 dB	
Input Sensitivity (8Ω)	1.53V RMS (Low) .79V RMS (High)	
Voltage Gain	X40	
Input Impedance (balanced)	>20kΩ	
Hum and Noise ("A" weighted, full power, 4Ω)	> -100 dB	
Crosstalk ("A" weighted, full power, 4Ω)	> -60dB	
Class	H (Low Channel); AB (High Channel)	
Input Connectors (per channel)	Female XLR (pin 3+), Octal Socket	
Output Connectors (per channel)	5-way output binding posts	
Filter Storage	80,000 μF	
Standard Power Supply (USA)	120V, 60Hz	
Idle Current Draw (120V)	1.2A	
1/8 Power Curr. Draw (typical music, 120V/4Ω)	7.0A	
1/3 Power Curr. Draw (continuous music, 120V/4Ω)	12.25A	
Max Curr. Draw (circuit breaker rating, 120V/4Ω)	21.0A	
Thermal Emissions (1/8 Power, 4Ω)	2300 BTU/hr	
Thermal Emissions (1/3 Power, 4Ω)	3700 BTU/hr	
Cooling	Rear to front tunnel heatsink, 2 variable speed DC fans	
Controls	Front panel: 2 attenuators, circuit breaker/power switch; Rear panel: signal ground lift jumper.	
LED Indicators (per channel)	Clip/Limit, Signal, Temp/DC, Active	
Construction	16 ga. steel chassis, 0.187" (5mm) aluminum front panel	
Dimensions (Height x Width x Depth)	3.5"x19"x15" (16" to rear ears) 89mm x 483mm x 381mm (406mm to rear ears)	
Gross Weight, Net Weight	57 lbs. (25.88 kg.), 52 lbs. (23.60 kg.)	
Warranty	5 years, parts and labor†	

† USA, Canada, U.K., and many other countries. Power figures are watts per channel, both channels driven. Crest Audio reserves the right to make improvements in manufacturing or design which may affect specifications. Crest Audio specification literature is available in downloadable PDF file format; visit our website at <http://www.crestaudio.com>. ©1997 Crest Audio Inc. 12/15/97

Appendix B - General Amplifier Specifications (Model 8001)

	1kHz, <0.025% THD+N	20Hz-20kHz, <0.1% THD+N
8Ω Stereo Power	750W	720W
4Ω Stereo Power	1225W	1200W
8Ω Bridged Mono Power	2450W	2250W
2Ω Stereo Power	1400W	1400W
4Ω Bridged Mono Power	2800W	2800W
Max RMS Output Voltage (each channel)	91V	
Peak Output Voltage (each channel)	129V	
Frequency Response (+0 / -0.3dB, 1W/8Ω)	20 Hz-20 kHz, -3dB @ 53kHz	
Power Bandwidth (rated power at 4Ω, 1% THD+N)	20 Hz-20 kHz, +0/-0.2dB	
Protection Circuitry	Clip Limit, IGM, AutoRamp, High Temp, short-circuit, DC voltage, turn-on/off transient, sub/ultrasonic input.	
THD+N (rated power at 4Ω, 1kHz)	<0.025%	
SMPTE IMD (rated power at 8Ω, 60Hz & 7kHz)	<0.1%	
Damping Factor (10-400Hz at 8Ω)	400:1	
Input CMRR (1kHz)	>60 dB	
Input Sensitivity (rated power at 4Ω)	1.75V RMS	
Voltage Gain	X40	
Input Impedance (balanced)	>20kΩ	
Hum and Noise ("A" weighted, full power, 4Ω)	> -100 dB	
Crosstalk ("A" weighted, full power, 4Ω)	> -60dB	
Class	H	
Input Connectors (per channel)	Female XLR (pin 3+), Octal Socket	
Output Connectors (per channel)	2 pair 5-way output binding posts	
Filter Storage	70,000 μF	
Standard Power Supply (USA)	120V, 60Hz	
Idle Current Draw (120V)	1.6A	
1/8 Power Curr. Draw (typical music, 120V/4Ω)	10.8A	
1/3 Power Curr. Draw (continuous music, 120V/4Ω)	21.8A	
Max Curr. Draw (circuit breaker rating, 120V/4Ω)	37.5A	
Thermal Emissions (1/8 Power, 4Ω)	3380 BTU/hr	
Thermal Emissions (1/3 Power, 4Ω)	6140 BTU/hr	
Cooling	Rear to front tunnel heatsink, 105 CFM AC fan, 2-speed optional.	
Controls	Front panel: 2 attenuators, circuit breaker/power switch; Rear panel: mode switch, signal ground lift jumper.	
LED Indicators (per channel)	Clip/Limit, Signal, Temp/DC, Active	
Construction	14 ga. steel chassis, 0.25" (6mm) aluminum front panel	
Dimensions (Height x Width x Depth)	5.25"x19"x15" (16" to rear ears) 133mm x 483mm x 381mm (406mm to rear ears)	
Gross Weight, Net Weight	85 lbs. (38.6 kg.), 80 lbs. (36.0 kg.)	
Warranty	5 years, parts and labor†	

† USA, Canada, U.K., and many other countries. Power figures are watts per channel, both channels driven. Crest Audio reserves the right to make improvements in manufacturing or design which may affect specifications. Crest Audio specification literature is available in downloadable PDF file format; visit our website at <http://www.crestaudio.com>. ©1997 Crest Audio Inc. 12/15/97

Appendix B - General Amplifier Specifications (Model 9001)

	1kHz, <0.02% THD+N	20Hz-20kHz, <0.1% THD+N
8Ω Stereo Power	1200W	1100W
4Ω Stereo Power	2200W	2050W
8Ω Bridged Mono Power	4400W	4100W
2Ω Stereo Power	3300W	3000W
4Ω Bridged Mono Power	6600W	6000W
Max RMS Output Voltage (each channel)	114V	
Peak Output Voltage (each channel)	161V	
Frequency Response (+0 / -0.3dB, 1W/8Ω)	20 Hz-20 kHz, -3dB @ 53kHz	
Power Bandwidth (rated power at 4Ω, 1% THD+N)	20 Hz-20 kHz, +0/-0.2dB	
Protection Circuitry	Clip Limit, IGM, AutoRamp, High Temp, short-circuit, DC voltage, turn-on/off transient, sub/ultrasonic input.	
THD+N (rated power at 4Ω, 1kHz)	<0.02%	
SMPTE IMD (rated power at 8Ω, 60Hz & 7kHz)	0.05%	
Damping Factor (10-400Hz at 8Ω)	200:1	
Input CMRR (1kHz)	>60 dB	
Input Sensitivity (rated power at 4Ω)	2.26V RMS	
Voltage Gain	X40	
Input Impedance (balanced)	>20kΩ	
Hum and Noise ("A" weighted, full power, 4Ω)	> -100 dB	
Crosstalk ("A" weighted, full power, 4Ω)	> -60dB	
Class	H	
Input Connectors (per channel)	Female XLR Input (pin 3+), Octal Socket.	
Output Connectors (per channel)	Single screw solderless copper output lugs.	
Filter Storage	46,000 μF	
Standard Power Supply (USA)	120V, 60Hz	
Idle Current Draw (120V)	2.0A	
1/8 Power Curr. Draw (typical music, 120V/4Ω)	16.2A	
1/3 Power Curr. Draw (continuous music, 120V/4Ω)	30.0A	
Max Curr. Draw (circuit breaker rating, 120V/4Ω)	65.0A	
Thermal Emissions (1/8 Power, 4Ω)	3850 BTU/hr	
Thermal Emissions (1/3 Power, 4Ω)	7700 BTU/hr	
Cooling	Rear to front tunnel heatsink, variable speed DC fan, 140 CFM max.	
Controls	Front panel: 2 attenuators, circuit breaker/power switch; Rear panel: mode switch, signal ground lift jumper.	
LED Indicators (per channel)	Clip/Limit, Signal, Temp/DC, Active	
Construction	12 ga. steel chassis, 0.187" (5mm) aluminum front panel	
Dimensions (Height x Width x Depth)	5 1/4" x 19" x 19.5", 133mm x 483mm x 496mm	
Gross Weight, Net Weight	115 lbs (52.21 kg.), 110 lbs (49.94 kg.)	
Warranty	5 years, parts and labor†	

† USA, Canada, U.K., and many other countries. Power figures are watts per channel, both channels driven. Crest Audio reserves the right to make improvements in manufacturing or design which may affect specifications. Crest Audio specification literature is available in downloadable PDF file format; visit our website at <http://www.crestaudio.com>. ©1997 Crest Audio Inc. 12/15/97

Appendix B - General Amplifier Specifications (Model 10001)

	20Hz-20kHz, <0.1% THD+N	Typical Music Prog. Material
2Ω Stereo Power	3500W	5000W
1Ω Stereo Power	5000W	7500W
4Ω Bridged Mono Power	7000W	10,000W
2Ω Bridged Mono Power	10,000W	15,000W
Max RMS Output Voltage (each channel)	105V	
Peak Output Voltage (each channel)	150V	
Frequency Response (+0 / -0.3dB, 1W/8Ω)	20 Hz-20 kHz, -3dB @ 53kHz	
Power Bandwidth (rated power at 4Ω, 1% THD+N)	20 Hz-20 kHz, +0/-0.2 dB	
Protection Circuitry	Clip Limit, IGM, AutoRamp, High Temp, short-circuit, DC voltage, turn-on/off transient, sub/ultrasonic input.	
THD+N (rated power at 4Ω, 1kHz)	<0.02%	
SMPTE IMD (rated power at 8Ω, 60Hz & 7kHz)	0.05%	
Damping Factor (10-400Hz at 8Ω)	580:1	
Input CMRR (1kHz)	>60 dB	
Input Sensitivity (rated power at 4Ω)	2.24V RMS	
Voltage Gain	X40	
Input Impedance (balanced)	>20kΩ	
Hum and Noise ("A" weighted, full power, 4Ω)	> -100 dB	
Crosstalk ("A" weighted, full power, 4Ω)	> -60dB	
Class H		
Input Connectors (per channel)	Female XLR Input (pin 3+), Octal Socket	
Output Connectors (per channel)	Single screw solderless copper output lugs.	
Filter Storage	29,200 μF	
Power Supply (factory configured)	100V–240V, 50–60Hz	
Idle Current Draw (120V)	2.0A per line cord	
1/8 Power Curr. Draw (typical music, 120V/4Ω)	13.0A per line cord	
1/3 Power Curr. Draw (continuous music, 120V/4Ω)	25.0A per line cord	
Max Curr. Draw (circuit breaker rating, 120V/4Ω)	35.6A per line cord	
Thermal Emissions (1/8 Power, 4Ω)	4450 BTU/hr	
Thermal Emissions (1/3 Power, 4Ω)	7908 BTU/hr	
Cooling	Rear to front tunnel, variable speed DC fan, 235 CFM max.	
Controls	Front panel: 2 attenuators, circuit breaker/power switch; Rear panel: mode switch, signal ground lift jumper.	
LED Indicators (per channel)	Clip/Limit, Signal, Temp/DC, Active	
Construction	12 ga. steel chassis, 0.075" (1.9mm) aluminum front panel	
Dimensions (Height x Width x Depth)	7" x 19" x 20.5" (19.5" to end of rear ears), 178mm x 483mm x 521mm (496mm to back of rear ears)	
Gross Weight, Net Weight	145 lbs (65.83 kg.), 137 lbs (62.20 kg.)	
Warranty	5 years, parts and labor†	

† USA, Canada, U.K., and many other countries. Power figures are watts per channel, both channels driven. Crest Audio reserves the right to make improvements in manufacturing or design which may affect specifications. Crest Audio specification literature is available in downloadable PDF file format; visit our website at <http://www.crestaudio.com>. ©1997 Crest Audio Inc. 12/15/97

Appendix B - General Amplifier Specifications (Model 10004)

	1kHz, <0.02% THD+N	20Hz-20kHz, <0.1% THD+N
8Ω Stereo Power (x4 ch.)	750W	720W
4Ω Stereo Power (x4 ch.)	1225W	1200W
8Ω Bridged Mono Power (x2 ch.)	2450W	2400W
2Ω Stereo Power (x4 ch.)	1400W	1400W
4Ω Bridged Mono Power (x2 ch.)	2800W	2800W
Max RMS Output Voltage (each channel)	91V	
Peak Output Voltage (each channel)	137V	
Frequency Response (+0 / -0.3dB, 1W/8Ω)	20 Hz-20 kHz, -3dB @ 53kHz	
Power Bandwidth (rated power at 4Ω, 1% THD+N)	20 Hz-20 kHz, +0/-0.2dB	
Protection Circuitry	Clip Limit, IGM, AutoRamp, High Temp, short-circuit, DC voltage, turn-on/off transient, sub/ultrasonic input.	
THD+N (rated power at 4Ω, 1kHz)	<0.02%	
SMPTE IMD (rated power at 8Ω, 60Hz & 7kHz)	0.06%	
Damping Factor (10-400Hz at 8Ω)	600:1	
Input CMRR (1kHz)	>60 dB	
Input Sensitivity (rated power at 4Ω)	1.7V RMS	
Voltage Gain	X40	
Input Impedance (balanced)	>20kΩ	
Hum and Noise ("A" weighted, full power, 4Ω)	> -100 dB	
Crosstalk ("A" weighted, full power, 4Ω)	> -60dB	
Class	H	
Input Connectors (per channel)	Female XLR (pin 3+), Octal Socket	
Output Connectors (per channel)	5-way output binding posts	
Filter Storage	168,000 μF per channel	
Power Supply (factory configured)	100V–240V, 50–60Hz	
Idle Current Draw (120V)	1.6A per line cord	
1/8 Power Curr. Draw (typical music, 120V/4Ω)	10.8A per line cord	
1/3 Power Curr. Draw (continuous music, 120V/4Ω)	21.8A per line cord	
Max Curr. Draw (circuit breaker rating, 120V/4Ω)	35.6A per line cord	
Thermal Emissions (1/8 Power, 4Ω)	3380 BTU/hr	
Thermal Emissions (1/3 Power, 4Ω)	6140 BTU/hr	
Cooling	Rear to front tunnel, 2 speed DC fan, 235 CFM max	
Controls	Front panel: 4 attenuators, 2 circuit breaker /power switches; Rear panel: 2 mode switches, signal ground lift jumper	
LED Indicators (per channel)	Clip/Limit, Signal, Temp/DC, Active	
Construction	12 ga. steel chassis, .093" (2.5mm) aluminum front panel	
Dimensions (Height x Width x Depth)	7" x 19" x 20.5" (19.5" to end of rear ears); 178mm x 483mm x 521mm (496mm to back of rear ears)	
Gross Weight, Net Weight	145 lbs (65.83 kg.), 137 lbs (62.20 kg.)	
Warranty	5 years, parts and labor†	

† USA, Canada, U.K., and many other countries. Power figures are watts per channel, both channels driven. Crest Audio reserves the right to make improvements in manufacturing or design which may affect specifications. Crest Audio specification literature is available in downloadable PDF file format; visit our website at <http://www.crestaudio.com>. ©1997 Crest Audio Inc. 12/15/97

Stranded Cable Lgth. (ft.)	Wire Gauge (AWG)	Power Loss (8 ohm load)	Power Loss (4 ohm load)	Power Loss (2 ohm load)
5	18	0.81%	1.61%	3.2%
	16	0.51	1.02	2.0
	14	0.32	0.64	1.28
	12	0.20	0.40	0.80
	10	0.128	0.25	0.51

10	18	1.61%	3.2%	6.2%
	16	1.02	2.0	4.0
	14	0.64	1.28	2.5
	12	0.40	0.80	1.60
	10	0.25	0.51	1.01

40	18	6.2%	11.9%	22%
	16	4.0	7.7	14.6
	14	2.5	5.0	9.6
	12	1.60	3.2	6.2
	10	1.01	2.0	4.0
	8	0.60	1.20	2.4

80	18	11.9%	22%	37%
	16	7.7	14.6	26
	14	5.0	9.6	17.8
	12	3.2	6.2	11.8
	10	2.0	4.0	7.7
	8	1.20	2.4	4.7

Stranded Cable Lgth. (m)	Wire Gauge (mm ²)	Power Loss (8 ohm load)	Power Loss (4 ohm load)	Power Loss (2 ohm load)
2	0.3	2.9%	5.6%	10.8%
	0.5	1.74	3.4	6.7
	0.75	1.16	2.3	4.5
	1.5	0.58	1.16	2.3
	2.5	0.35	0.70	1.39
	4	0.22	0.44	0.87

5	0.5	4.3%	8.2%	15.5%
	0.75	2.9	5.6	10.8
	1.5	1.45	2.9	5.6
	2.5	0.87	1.74	3.4
	4	0.55	1.09	2.2
	6	0.37	0.73	1.45

10	0.5	8.24%	15.5%	28%
	0.75	5.6	10.8	19.9
	1.5	2.9	5.6	10.8
	2.5	1.74	2.9	6.7
	4	1.09	1.74	4.3
	6	0.73	1.09	2.9

30	0.75	15.5%	25%	45%
	1.5	8.2	15.5	28
	2.5	5.1	9.8	18.2
	4	3.2	6.3	12.0
	6	2.2	4.3	8.2
	10	1.31	2.6	5.1

Appendix D

Meyer-Compatible Power Amplifiers

The Crest Audio Models MA5850, MA9130, and MA7120 Professional power amplifiers are specifically designed in close cooperation with Meyer Sound Laboratories to meet the needs of the European Meyer Sound loudspeaker user. This manual describes all of the important aspects of amplifier installation, mounting, connection and operation. Additional information pertaining to these power amplifiers is provided in this appendix.

MA5850 - Based on the Crest Audio Professional Series 4801 power amplifier, the MA5850 contains custom circuitry to limit output to 58V RMS per channel, effectively preventing driver over-exursion on the models for which it is intended. As the power supply of the MA5850 is capable of much greater output, this design also reduces possible damage from clipped waveforms. The MA5850 is specifically designed as a Meyer Type 1 power amplifier. The gain setting is 23 dB at Meyer's recommendation.

MA9130 - The MA9130 is based on the Crest Audio Professional Series 8001 power amplifier, using a custom designed, low noise two speed fan and custom circuitry for operation as a Meyer Type 2 Power Amplifier. The MA9130 gain setting is also 23 dB.

MA7120 - The MA7120, based on the Crest Audio Professional Series 6001 and 7001 power amplifiers, is intended for bridged mode operation, with a voltage gain of 6.3 (+16 dB). It has been specifically designed to meet the high power requirements of a Meyer Type 3 power amplifier.

Warranty applicable in USA, Canada, U.K., and many other countries. Power figures are watts per channel, both channels driven. Crest Audio reserves the right to make improvements in manufacturing or design which may affect specifications. Crest Audio specification literature is available in downloadable PDF file format; visit our website at <http://www.crestaudio.com>. ©1996 Crest Audio Inc.

MA5850		1kHz, <0.05% THD+N	20Hz-20kHz, <0.1% THD+N
8Ω Stereo Power		400W	300W
4Ω Stereo Power		575W	480W
8Ω Bridged Mono Power		1150W	960W
Max RMS Output Voltage (each channel)		58V	
Peak Output Voltage (each channel)		82V	
Frequency Response (+0 / -0.3dB, 1W/8Ω)		20 Hz-20 kHz, -3dB @ 53kHz	
Power Bandwidth (rated power at 4Ω, 1% THD+N)		20 Hz-20 kHz, +0/-0.2dB	
Protection Circuitry		Clip Limit, IGM, AutoRamp, High Temp, short-circuit, DC voltage, turn-on/off transient, sub/ultrasonic input.	
THD+N (rated power at 8Ω, 1kHz)		<0.05%	
SMPTE IMD (rated power at 8Ω, 60Hz & 7kHz)		<0.015%	
Damping Factor (10-400Hz at 8Ω)		400:1	
Input CMRR (1kHz)		>60 dB	
Input Sensitivity (rated power at 4Ω)		3.5V RMS	
Voltage Gain		X14 (+23dB)	
Input Impedance (balanced)		>20kΩ	
Hum and Noise ("A" weighted, full power, 4Ω)		>-100 dB	
Crosstalk ("A" weighted, full power, 4Ω)		>-60dB	
Class		H	
Input Connectors (per channel)		Female XLR (pin 3+), Octal Socket	
Output Connectors (per channel)		5-way output binding posts	
Filter Storage		80,000 μF	
Power Supply (factory configured)		100V-240V, 50-60Hz	
Idle Current Draw (240V)		.55A	
1/8 Power Curr. Draw (typical music, 120V/4Ω)		2.8A	
1/3 Power Curr. Draw (continuous music, 120V/4Ω)		5.75A	
Max Curr. Draw (circuit breaker rating, 120V/4Ω)		10.0A	
Thermal Emissions (1/8 Power, 4Ω)		1803 BTU/hr	
Thermal Emissions (1/3 Power, 4Ω)		3385 BTU/hr	
Cooling		Rear to front tunnel heatsink, variable speed DC fan	
Controls		Front panel: 2 attenuators, circuit breaker/power switch; Rear panel: mode switch, signal ground lift jumper.	
LED Indicators (per channel)		Clip/Limit, Signal, Temp/DC, Active	
Construction		16 ga. single piece steel chassis, .187" (5mm) alum. front panel	
Dimensions (Height x Width x Depth)		3.5"x19"x15" (16" to rear ears) 89mm x 483mm x 381mm (406mm to rear ears)	
Gross Weight, Net Weight		54.0 lbs (24.52 kg.), 49.0 lbs (22.25 kg.)	
Warranty		5 years, parts and labor†	

† USA, Canada, U.K., and many other countries. Power figures are watts per channel, both channels driven. Crest Audio reserves the right to make improvements in manufacturing or design which may affect specifications. Crest Audio specification literature is available in down-

MA7120

	1kHz, <0.03% THD+N	20Hz-20kHz, <0.1% THD+N
8Ω Bridged Mono Power	1150W	975W
4Ω Bridged Mono Power	1200W	1100W
Max RMS Output Voltage (bridged)	140V	
Peak Output Voltage (bridged)	198V	
Frequency Response (+0 / -0.3dB, 1W/8Ω)	20 Hz-20 kHz, -3dB @ 53kHz	
Power Bandwidth (rated power at 4Ω, 1% THD+N)	20 Hz-20 kHz, +0/-0.2dB	
Protection Circuitry	Clip Limit, IGM, AutoRamp, High Temp, short-circuit, DC voltage, turn-on/off transient, sub/ultrasonic input.	
THD+N (rated power, 1kHz)	<0.03%	
SMPTE IMD (rated power at 8Ω, 60Hz & 7kHz)	<0.5%	
Damping Factor (10-400Hz at 8Ω)	400:1	
Input CMRR (1kHz)	>60 dB	
Input Sensitivity (rated power at 4Ω bridged)	10.5V RMS for 1100W at 4Ω bridged	
Voltage Gain	X6.3 (+16dB) bridged	
Input Impedance (balanced)	>20kΩ	
Hum and Noise ("A" weighted, full power, 4Ω)	>-100 dB	
Crosstalk ("A" weighted, full power, 4Ω)	>-60dB	
Class	H	
Input Connectors (per channel)	Female XLR (pin 3+), Octal Socket	
Output Connectors (per channel)	5-way output binding posts	
Filter Storage	120,000 μF	
Power Supply (factory configured)	100V-240V, 50-60Hz	
Idle Current Draw (120V)	0.7A	
1/8 Power Curr. Draw (typical music, 120V/4Ω)	3.9A	
1/3 Power Curr. Draw (continuous music, 120V/4Ω)	7.75A	
Max Curr. Draw (circuit breaker rating, 120V/4Ω)	15.0A	
Thermal Emissions (1/8 Power, 4Ω)	2503 BTU/hr	
Thermal Emissions (1/3 Power, 4Ω)	4505 BTU/hr	
Cooling	Rear to front tunnel heatsink, 2 variable speed DC fans	
Controls	Front panel: 2 attenuators, circuit breaker/power switch; Rear panel: mode switch, signal ground lift jumper.	
LED Indicators (per channel)	Clip/Limit, Signal, Temp/DC, Active	
Construction	16 ga. single piece steel chassis, .187" (5mm) alum. front panel	
Dimensions (Height x Width x Depth)	3.5"x19"x15" (16" to rear ears) 89mm x 483mm x 381mm (406mm to rear ears)	
Gross Weight, Net Weight	57 lbs. (25.88 kg.), 52 lbs. (23.60 kg.)	
Warranty	5 years, parts and labor†	

† USA, Canada, U.K., and many other countries. Power figures are watts per channel, both channels driven. Crest Audio reserves the right to change specifications without notice.

MA9130

	1kHz, <0.025% THD+N	20Hz-20kHz, <0.1% THD+N
8Ω Stereo Power	750W	720W
4Ω Stereo Power	1225W	1200W
8Ω Bridged Mono Power	2450W	2250W
2Ω Stereo Power	1400W	1400W
4Ω Bridged Mono Power	2800W	2800W
Max RMS Output Voltage (each channel)	91V	
Peak Output Voltage (each channel)	129V	
Frequency Response (+0 / -0.3dB, 1W/8Ω)	20 Hz-20 kHz, -3dB @ 53kHz	
Power Bandwidth (rated power at 4Ω, 1% THD+N)	20 Hz-20 kHz, +0/-0.2dB	
Protection Circuitry	Clip Limit, IGM, AutoRamp, High Temp, short-circuit, DC voltage, turn-on/off transient, sub/ultrasonic input.	
THD+N (rated power at 4Ω, 1kHz)	<0.025%	
SMPTE IMD (rated power at 8Ω, 60Hz & 7kHz)	<0.1%	
Damping Factor (10-400Hz at 8Ω)	400:1	
Input CMRR (1kHz)	>60 dB	
Input Sensitivity (rated power at 4Ω)	1.75V RMS	
Voltage Gain	X14 (+23 dB)	
Input Impedance (balanced)	>20kΩ	
Hum and Noise ("A" weighted, full power, 4Ω)	> -100 dB	
Crosstalk ("A" weighted, full power, 4Ω)	> -60dB	
Class	H	
Input Connectors (per channel)	Female XLR (pin 3+), Octal Socket	
Output Connectors (per channel)	2 pair 5-way output binding posts	
Filter Storage	70,000 μF	
Power Supply (factory configured)	100V-240V, 50-60Hz	
Idle Current Draw (240V)	0.8A	
1/8 Power Curr. Draw (typical music, 240V/4Ω)	5.4A	
1/3 Power Curr. Draw (continuous music, 240V/4Ω)	10.9A	
Max Curr. Draw (circuit breaker rating, 240V/4Ω)	19.0A	
Thermal Emissions (1/8 Power, 4Ω)	3380 BTU/hr	
Thermal Emissions (1/3 Power, 4Ω)	6140 BTU/hr	
Cooling	Rear to front tunnel heatsink, low-noise 2-speed fan	
Controls	Front panel: 2 attenuators, circuit breaker/power switch; Rear panel: mode switch, signal ground lift jumper.	
LED Indicators (per channel)	Clip/Limit, Signal, Temp/DC, Active	
Construction	14 ga. steel chassis, 0.25" (6mm) aluminum front panel	
Dimensions (Height x Width x Depth)	5.25"x19"x15" (16" to rear ears) 133mm x 483mm x 381mm (406mm to rear ears)	
Gross Weight, Net Weight	85 lbs. (38.6 kg.), 80 lbs. (36.0 kg.)	
Warranty	5 years, parts and labor†	

† USA, Canada, U.K., and many other countries. Power figures are watts per channel, both channels driven. Crest Audio reserves the right to change specifications without notice.



Crest Audio Inc.
100 Eisenhower Dr., Paramus NJ 07652 USA
TEL: 201.909.8700 FAX: 201.909.8744
<http://www.crestaudio.com>

Printed in USA

Power is serious business.

v. 1.6 12/15/97 © 1997 Crest Audio, Inc.



C100005